

arthema[®]
SYSTEM
Catalogo Tecnico 2009 .1

Gentile Cliente, per una facile lettura del catalogo, Vi invitiamo a consultare questa legenda.
 Dear Customer, please read the following guidelines for a better understanding of our catalogue.
 Sehr geehrter Kunde, bitte lesen Sie die folgenden Zeichenerklärungen für ein besseres Verständnis unseres Katalogs.
 Cher client, pour simplifier la lecture du catalogue, Vous pouvez consulter cette légende.
 Уважаемый клиент, для лучшего понимания Каталога предлагаем Вам прочесть данное толкование.

TYPE 20	COD.	A (mm)	B (mm)	KG	Capacity
	AL2001--0000	600	350	0,89	40
	AL2002--0000	900	350	1,32	35

Barra appenderia staccata.
 Outdistanced hanging bar.
 Lose Abhängestange.
 Barre d'accrochage décalée.
 Выступающее вешало.

① **Immagine prodotto - Item picture - Abbildung artikel - Image produit - Изображение артикула**

In questa casella è riportata un'immagine indicativa del prodotto non imballato; si precisa che tale immagine è da considerarsi come una rappresentazione grafica non vincolante ai fini delle caratteristiche tecniche del prodotto.
 This box contains a picture of the unpacked article. This picture is just as an indication, and it is therefore meant as a graphic representation, which is not as worth as a technical report.
 Auf diesem Kästchen steht eine Abbildung des unverpackten Artikels. Diese Abbildung gilt sowieso nur als eine graphische Darstellung, die nicht verbindlich als technische Daten zu betrachten ist.
 Ici Vous verrez une image du produit pas emballé. Cette image devra être considérée seulement comme une représentation graphique pas liée aux caractéristiques techniques du produit.
 В данной графе приводится изображение изделия без упаковки; уточняем, что данный рисунок является условным изображением, не связанным с техническими характеристиками изделия.

② **Codice prodotto - Item code - Kode Artikel - Code produit - Код артикул**

●(A) Il codice articolo è composto da 12 caratteri alfanumerici e deve essere utilizzato per meglio indicare il materiale da ordinare.
 The item code is composed of 12 alphanumeric types and should be used to mark the ordered material.
 Der Artikelcode besteht aus 12 alphanumerischen Schriftzeichen und muss zur genauen Beschreibung der bestellten Produkten benutzt werden.
 Le code article est composé par 12 caractères alfa-numériques et doit être utilisé pour mieux indiquer le matériel qu'on désire acheter.
 Код артикула состоит из 12 знаков и используется для наилучшего указания изделия в заказе.

●(B) Le due cifre inserite in questa posizione indicano la tipologia di finitura del prodotto.
 The two digits in this position stand for the type of finish.
 Die zwei Zahlen auf dieser Stelle kennzeichnen die Ausführung des Artikels.
 Les deux chiffres qui se trouvent ici indiquent la finition de l'article.
 Две цифры в данном расположении указывают тип отделки изделия.

③ **Misure prodotto - Item sizes- Maß artikel - Mesure produit - Размеры артикула**

④ **Peso prodotto - Item weight - Gewicht des Artikels - Poids produit - Вес артикула**

In questa casella è indicato il peso del prodotto non imballato espresso in chilogrammi.
 This box indicates the weight of an unpacked item in kilograms.
 Auf diesem Kästchen steht das Gewicht eines unverpackten Artikels in Kg.
 Dans cette boîte est indiqué le poids du produit déballé en Kilos.
 В этой графе указан вес артикула, выраженный в кг. без упаковки.

⑤ **Portata prodotto - Capacity - Tragfähigkeit - Portée du produit - Максимальная нагрузка**

Espressa in Kg. essa si riferisce al peso massimo sopportabile ed equamente distribuito. La portata del prodotto è da ritenersi comunque indicativa e non vincolante per Arthemagroup, che non si assume alcuna responsabilità circa il non corretto utilizzo del prodotto venduto.
 The capacity, indicated in kilograms, refers to the maximum weight evenly distributed that an item can accommodate. The stated capacity is indicative and non-binding for Arthemagroup, which shall not be held responsible for any damage resulting from an improper use of any sold item.
 Die Tragfähigkeit – hier in Kilogramm – bezieht sich auf das maximale, gleich verteilte Gewicht, das ein Artikel tragen kann. Die Tragfähigkeit versteht sich als eine nicht verbindliche Richtangabe und Arthemagroup haftet nicht für Schaden, die bei einer unrichtigen Benutzung des verkauften Produkts entstehen.
 La portée du produit est indiquée en kilos. Elle se réfère au poids maximum et distribué en parts égales que le produit peut soutenir. Elle est toutefois approximative et pas contraignante pour Arthemagroup qui n'a aucune responsabilité sur l'usage pas correct du produit une fois il est vendu.
 Выраженная в кг, обозначает максимальный вес равномерно распределенного товара. Просьба учесть тот факт, что этот показатель довольно относительная величина и Arthemagroup не берет на себя никакой ответственности за некорректное использование проданного материала.

⑥ **Uso prodotto - Usage of the product - Benutzung des Produkts - Usage du produit - Использование продукции**



In questa casella è indicato il corretto uso del prodotto sul sistema di riferimento.
 This box explains how to use correctly the product on its system.
 Auf diesem Kästchen steht die korrekte Benutzung des Produkts auf das System.
 Dans cette boîte est indiqué l'usage correct du produit sur le système dont il fait partie.
 В этой графе приведены советы о правильном использовании соответствующих систем.

⑦ **Descrizione tecnica del prodotto - Technical description of the item - Technische Daten des Artikels - Description technique de l'article - Техническое описание артикула**

In questa casella è riportato il TYPE del prodotto ed anche una breve DESCRIZIONE dello stesso. Occasionalmente è possibile trovare anche la dicitura "F.S." seguita da un numero/signa che rappresenta la sola finitura di serie per quel type.
 Here you can find the Type of the item and a brief description of it. Occasionally it's possible to find the inscription "S.F" as well followed by a number/mark representing the only standard finishing for that type.
 Auf diesem Kästchen wird der Artikeltyp mit dessen kurzer Beschreibung eingeführt. Eventuell erscheint die Abkürzung "S.F." auch vor einer Anzahl/Kennwort. Diese Anzahl stellt die einzige Standardausführung für diesen Typ dar.
 Ici Vous trouverez le TYPE du produit et aussi une brève description du même. De temps en temps il est possible de trouver la forme "F.S." aussi, suivie d'un nombre/signa qui représente la seule finition de série pour ce type-là.
 В данной графе указывается ТИП артикула, а также его краткое описание. Иногда можно увидеть надпись "С.О.", за которой следуют другие сокращения, которые означают единственные возможные серийные отделки для данного типа.

TYPE 1

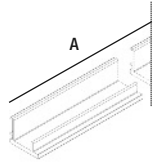

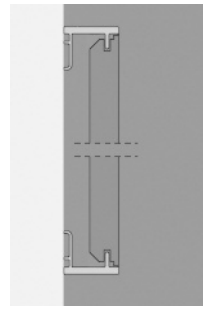
COD.	A (mm)	KG
IN0101--0000	1200	0,768
IN0102--0000	1800	1,152
IN0103--0000	6100	3,904

Profilo di partenza e di chiusura pannello in legno.
Start and end profile for wooden panel.
Anfangs- und Abschlussprofil für Holzpaneel.
Profil de début et profil terminale pour panneau en bois.
Начальный и конечный профиль для деревянной панели.

TYPE 2

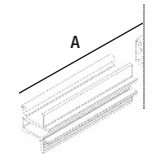

COD.	A (mm)	KG
IN0201--0000	1200	0,816
IN0202--0000	1800	1,224
IN0203--0000	6100	4,148

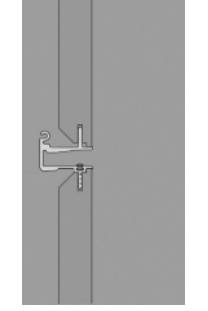
Profilo (S8) per pannelli legno - legno.
Joint profile for wooden - wooden panels.
Profil zwischen Holzpaneel und Holzpaneel.
Profil pour panneaux en bois - bois.
Профиль (S8) для дерева - дерево .

TYPE 3

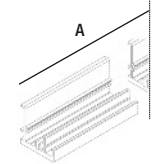

COD.	A (mm)	KG
IN0301--0000	1200	0,816
IN0302--0000	1800	1,224
IN0303--0000	6100	4,148

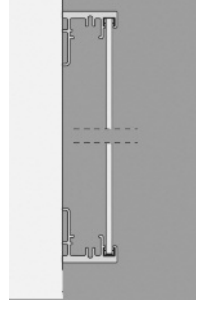
Profilo di partenza e chiusura per vetro.
Start and end profile for glass panel.
Anfangs- und Abschlussprofil für Glaspaneel.
Profil de début et profil terminale pour panneau en verre.
Начальный и конечный профиль для стеклянной панели

TYPE 4

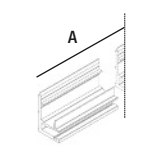

COD.	A (mm)	KG
IN0401--0000	1200	1,428
IN0402--0000	1800	2,142
IN0403--0000	3650	4,343

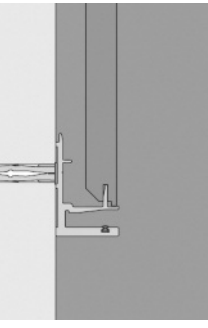
Profilo (S8) di partenza pannello legno.
Start profile for wooden panel.
Anfangsprofil für Holzpaneel.
Profil de début pour panneau en bois.
Начальный профиль для деревянной панели.

TYPE 5

COD.	A (mm)	KG
IN0501--0000	1200	1,128
IN0502--0000	1800	1,692
IN0503--0000	6100	5,734

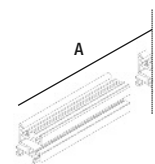
Profilo (S8) per vetro - vetro.
Joint profile for glass - glass panels.
Profil zwischen Glaspaneel und Glaspaneel.
Profil pour verre - panneau en verre.
Профиль (S8) для стекла - стекло.

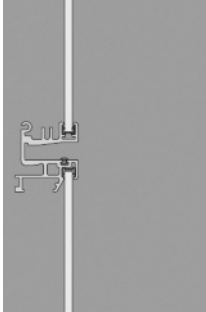
TYPE 6

COD.	A (mm)	KG
IN0601--0000	1200	0,744
IN0602--0000	1800	1,116
IN0603--0000	6100	3,782





Profilo (S8) per pannello legno - vetro.
Joint profile for wooden - glass panels.
Profil zwischen Holzpaneel und Glaspaneel.
Profil pour panneau en bois - verre.
Профиль для стыка стеклянной и деревянной панелей.

TYPE 7

COD.	A (mm)	KG
IN0701--0000	1200	1,068
IN0702--0000	1800	1,602
IN0703--0000	6100	5,429

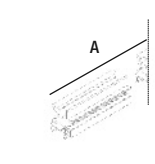

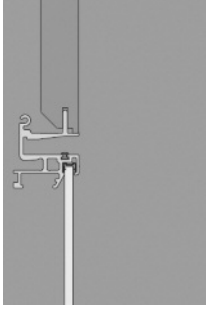



Profilo (S8) per vetro - pannello legno.
Joint profile for glass - wooden panels
Profil zwischen Glaspaneel und Holzpaneel.
Profil pour verre - panneau en bois.
Профиль для стыка стеклянной и деревянной панелей.

TYPE 8

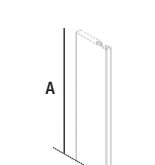
COD.	A (mm)	KG
IN0801--0000	3000	1,080





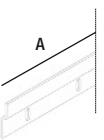

Profilo di copertura laterale.
Side cover profile.
Profil zur Seitenabdeckung.
Profil de couverture latérale.
Боковой профиль.

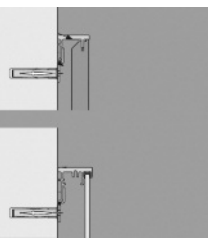
TYPE 9	COD.	A (mm)	KG
	IN0901--0000	1200	0,252
	IN0902--0000	1800	0,378
	IN0903--0000	6100	1,281

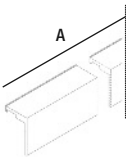

 Profilo di aggancio di ultimo pannello.
 Fastening profile for last panel.
 Kupplungsprofil für letztes Paneel.
 Profil de blocage pour dernier panneau.
 Профиль сцепления для последней панели.



TYPE 10	COD.	A (mm)	KG
	IN1001--0000	2400	1,872

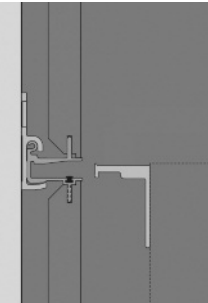

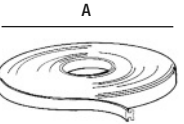
 Supporto contenitori.
 Supporting unit for containers.
 Träger für Behälter.
 Support pour récipients.
 Крепежный элемент для экспозиторов.



TYPE 11	COD.	A (mm)	KG
	IN1101--0000	1000	0,01

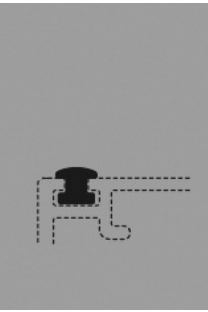

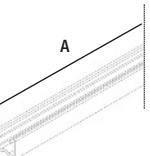
 Guarnizione antiscivolamento (al metro).
 Antislip seal (per metre).
 Rutschfeste Dichtungstreifen (je Meter).
 Joint anti-glissance (par mètre).
 Противоскользящая пленка (за метр).



TYPE 12	COD.	A (mm)	KG
	IN1201--0000	2650	0,027

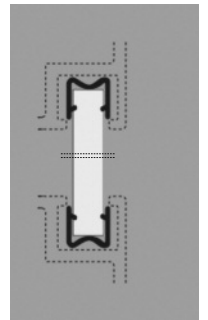

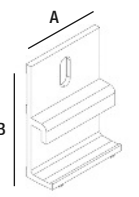
 Guarnizione per vetro sp.4 mm.
 Joint for 4 mm thick glass.
 Halterung für 4 mm dickes Glas.
 Joint pour verre épaisseur 4 mm.
 Крепеж для стекла толщ. 4 мм.



TYPE 13	COD.	A (mm)	B (mm)	KG
	IN1301--0000	40	57	0,053

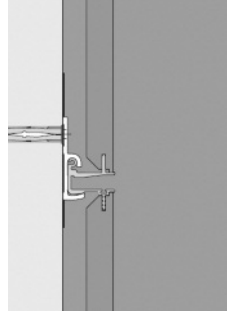

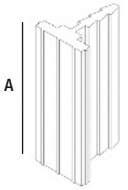
 Staffa di fissaggio a muro per profilo.
 Wall clamp for profiles.
 Wandbefestigungsbügel für Profil.
 Etrier de fixation au mur pour profil.
 Крепеж для профиля к стене.



TYPE 14	COD.	A (mm)	KG
	IN1401--0000	30	0,002

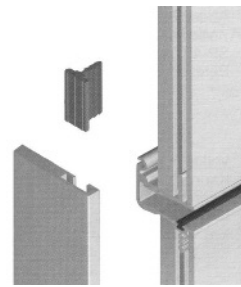

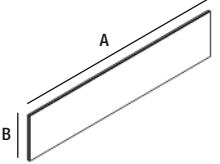
 Giunto di collegamento copertura laterale per pannelli legno.
 Side cover joint for wooden panels.
 Verbinder zur Seitenabdeckung für Holzpaneele.
 de connexion couverture latérale pour panneaux en bois.
 Соединитель бокового профиля с деревянной панелью.

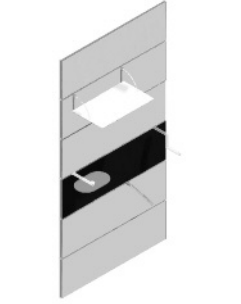

TYPE 15	COD.	A (mm)	B (mm)	C (mm)	KG
	IN1501--0000	1800	387	19	9,32
	IN1502--0000	1200	387	19	6,444

 Pannello in legno con bordi fresati.
 Wooden panel with milled edges.
 Holzpaneel mit gefrästen Kanten.
 Panneau en bois rainuré.
 Деревянная панель с фрезерованным бортиком.

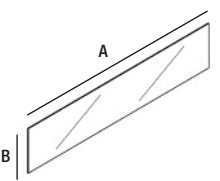

TYPE 16	COD.	A (mm)	B (mm)	C (mm)	KG
	IN1601--0000	1200	380	4	4,62
	IN1602--0000	1800	380	4	6,93

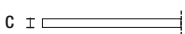
 Pannello in cristallo acidato.
 Etched crystal panel.
 Satiniertes Glaspaneel.
 Panneau en cristal acidé.
 Панель из сатирированного стекла.

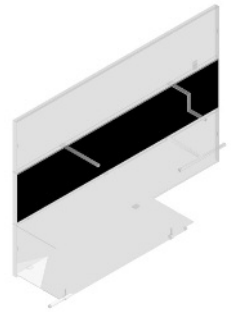

TYPE 17

COD.	A (mm)	B (mm)	C (mm)	KG
IN1701--0000	600	150	7,7	1,248
IN1702--0000	900	150	7,7	1,872
IN1703--0000	1200	150	7,7	2,496

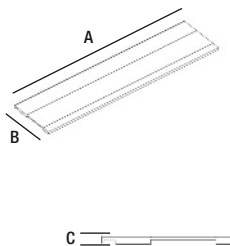

Ripiano (S8) in alluminio.
Aluminium shelf.
Alu-Boden.
Etagère en aluminium.
Алюминиевая полка.



TYPE 18

COD.	A (mm)	B (mm)	C (mm)	KG
IN1801--0000	600	150	50	1,384
IN1802--0000	900	150	50	1,996
IN1803--0000	1200	150	50	2,609

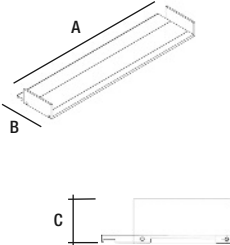

Ripiano (S8) in alluminio con fianchi.
Aluminium shelf with high sides.
Alu-Boden mit hohen Seiten.
Etagère en aluminium avec bords.
Алюминиевая полка с бортиками.



TYPE 19

COD.	A (mm)	B (mm)	C (mm)	KG
IN1901--0000	600	150	7,7	0,978
IN1902--0000	900	150	7,7	1,467
IN1903--0000	1200	150	7,7	1,956

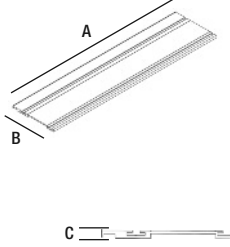

Ripiano (S8) con guide per separatori.
Shelf with guides for dividers.
Boden mit Führungen für Trenner.
Etagère avec profils guide pour séparations.
Полка с направляющими для разделителей.



TYPE 20

COD.	A (mm)	KG
IN2001--0000	100	0,04

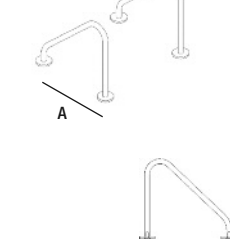

Coppia separatori per ripiano con guide.
Set of dividers for shelves with guides.
Doppeltrenner für Boden mit Führungen.
Couple séparations pour étagère avec profils guide.
Набор разделителей для полок с направляющими.

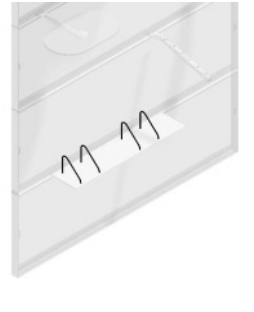

TYPE 21

COD.	A (mm)	B (mm)	KG
IN2101--0000	270	150	0,769

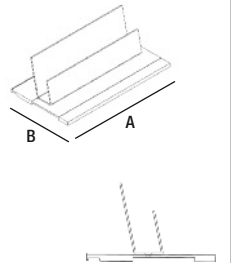

Ripiano (S8) portariviste.
Magazine rack.
Zeitungshalter.
Etagère porte-revues.
Полка для журналов.



TYPE 22

COD.	A (mm)	KG
IN2201--0000	50	0,075
IN2202--0000	2400	3,576

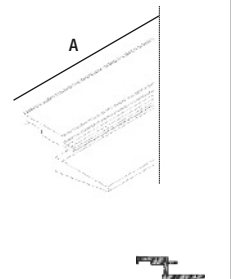

Profilo (S8) supporto ripiano continuo.
Shelf supporting profile.
Fachträger-Profil.
Profil de support pour étagère.
Профиль-держатель для полки.

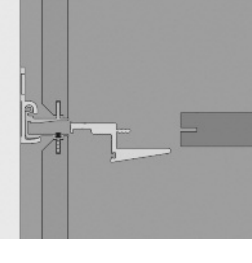

TYPE 23

COD.	A (mm)	B (mm)	C (mm)	KG	☰
IN2301--0000	1200	350	18	5,02	9
IN2302--0000	900	350	18	3,76	8
IN2303--0000	600	350	18	2,51	7

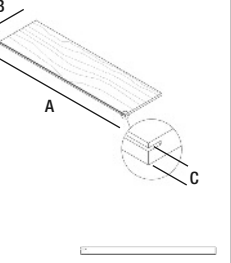

Ripiano in legno fresato.
Milled wooden shelf.
Gefrästes Holzfach.
Etagère en bois rainuré.
Деревянная полка с фрезеровкой.



TYPE 24

COD.	A (mm)	KG	☰
IN2401--0000	180	0,189	2x2,5

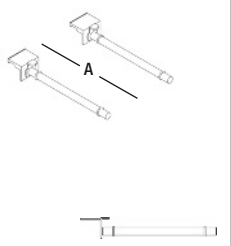

Coppia mensole (S8) per ripiani.
Set of brackets for shelves.
Doppeltträger für Böden.
Couple consoles pour étagères.
Набор полкодержателей.



TYPE 25

COD.	A (mm)	KG	📦
IN2501--0000	254,5	0,091	2x2

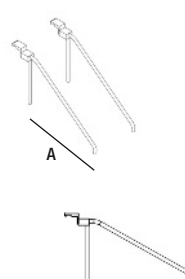

Coppia supporti obliqui (S8) per ripiano in legno.
Set of slanted supporting elements for wooden shelf.
Schräge Doppelträger für Holzboeden.
Couple consoles inclinées pour étagère en bois.
Набор наклонных держателей для деревянных полок.

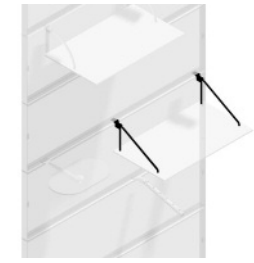

TYPE 26

COD.	A (mm)	KG	📦
IN2601--0000	147,5	0,094	2x2

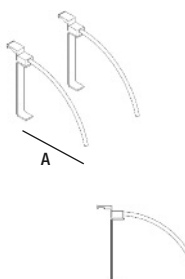

Coppia supporti curvi (S8) per ripiano sp.8 mm.
Set of curved supporting elements for a 8 mm thick shelf.
Gekrümmter Doppelträger für 8 mm dicken Boden.
Couple consoles courbées pour étagère en bois épaisseur 8 mm.
Набор закругленных держателей для полок толщ. 8 мм.

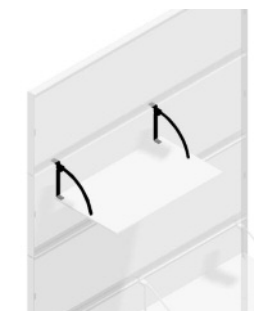

TYPE 27

COD.	A (mm)	KG
IN2701--0000	80	0,122

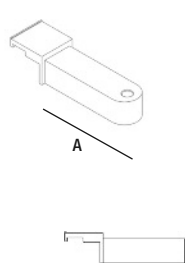

Supporto (S8) portaccessori vari.
Supporting element for accessory holders.
Träger für Zubehör-Halter.
Support porte-accessoires.
Держатель для экспозитора.

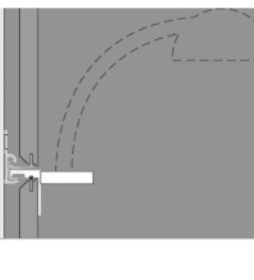

TYPE 28

COD.	A (mm)	B (mm)	C (mm)	KG
IN2801--0000	600	350	8	2,005
IN2802--0000	900	350	8	3,01
IN2803--0000	1200	350	8	4,01

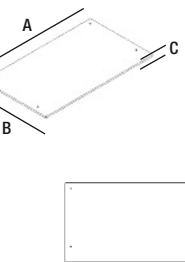

Ripiano in plexiglass con 4 fori.
Plexiglass shelf with 4 holes.
Boden aus Plexiglass mit 4 Löchern.
Etagère en plexiglass avec 4 trous.
Полка из плексиглас с 4-мя отверстиями.

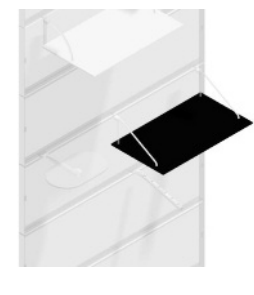

TYPE 29

COD.	A (mm)	B (mm)	C (mm)	KG
IN2901--0000	600	350	8	2,005
IN2902--0000	900	350	8	3,01
IN2903--0000	1200	350	8	4,01

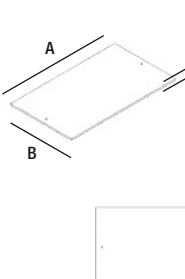

Ripiano in plexiglass con 2 fori.
Plexiglass shelf with 2 holes.
Boden aus Plexiglass mit 2 Löchern.
Etagère en plexiglass avec 2 trous.
Полка из плексиглас с 2-мя отверстиями.

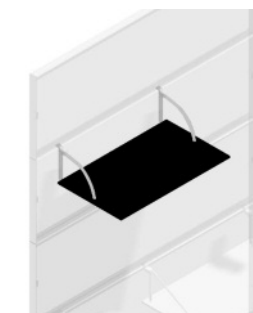

TYPE 30

COD.	A (mm)	B (mm)	C (mm)	KG	📦
IN3001--0000	600	380	8	2,18	8
IN3002--0000	900	380	8	3,27	10
IN3003--0000	1200	380	8	4,355	12

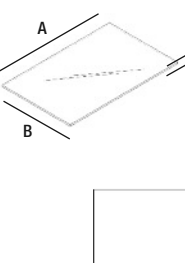

Ripiano in plexiglass
Plexiglass shelf.
Boden aus Plexiglass.
Etagère en plexiglass.
Полка из плексиглас.

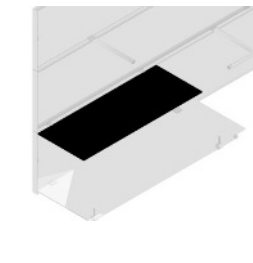

TYPE 31

COD.	A (mm)	B (mm)	C (mm)	KG	📦	*
IN3101--0000	600	380	8	4,56	12	
IN3102--0000	900	380	8	6,84	16	
IN3103--0000	1200	380	8	9,12	20	

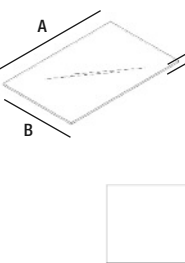

Ripiano in cristallo acidato.
Etched crystal shelf.
Satiniertes Glasfach.
Etagère en cristal acidé.
Полка из сатинированного стекла.

* Per ottenere una maggiore portata si consigliano i TYPE 48 e 49.
To achieve a higher capacity we recommend you use types 48 and 49.
Um eine höhere Tragfähigkeit zu haben, benutzen Sie Typ 48 und 49.
Pour obtenir une majeure capacité de charge les types 48 et 49 sont conseillés.
Для максимальной грузоподъемности рекомендуется использование TYPE 48 и 49.

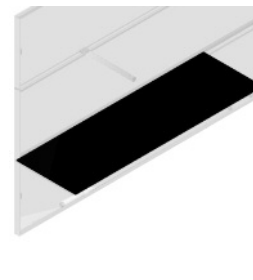

TYPE 32

COD.	A (mm)	B (mm)	C (mm)	KG	📦	*
IN3201--0000	600	380	8	4,925	12	

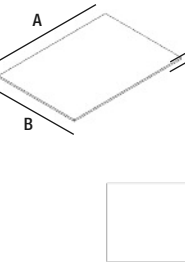

Ripiano in alluminio sp.8 mm.
8 mm thick aluminium shelf.
8 mm dicker Alu-Boden.
Etagère en aluminium épaisseur 8 mm.
Алюминиевая полка толщ. 8 мм.

* Per ottenere una maggiore portata si consigliano i TYPE 48 e 49.
To achieve a higher capacity we recommend you use types 48 and 49.
Um eine höhere Tragfähigkeit zu haben, benutzen Sie Typ 48 und 49.
Pour obtenir une majeure capacité de charge les types 48 et 49 sont conseillés.
Для максимальной грузоподъемности рекомендуется использование TYPE 48 и 49.

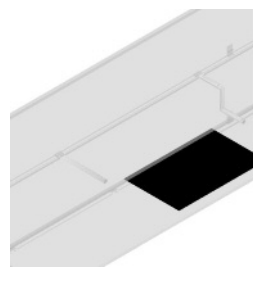

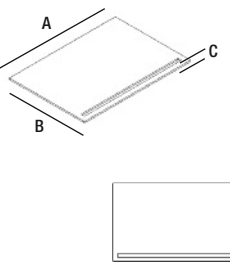
TYPE 33	COD.	A (mm)	B (mm)	C (mm)	KG	★
	IN3301--0000	600	425	8	5,508	12
<p>Ripiano in alluminio sp.8 mm con asola. 8 mm thick aluminium slotted bar. 8 mm dicker Alu-Boden mit Lochung. Etagère en aluminium avec perforation épaisseur 8 mm. Алюминиевая полка толщ. 8 мм с отверстием.</p> <p>★ Per ottenere una maggiore portata si consigliano i TYPE 48 e 49. To achieve a higher capacity we recommend you use types 48 and 49. Um eine höhere Tragfähigkeit zu haben, benutzen Sie Typ 48 und 49. Pour obtenir une majeure capacité de charge les types 48 et 49 sont conseillés. Для максимальной грузоподъемности рекомендуется использование TYPE 48 и 49.</p>						

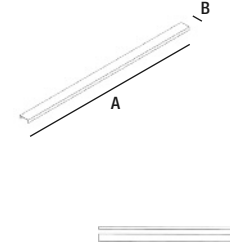
TYPE 34	COD.	A (mm)	B (mm)	KG
	IN3401--0000	540	27	0,147
<p>Profilo per ripiano in alluminio con asola. Profile for aluminium slotted shelf. Profil für Alu-Boden mit Lochung. Profil pour étagère en aluminium avec perforation. Профиль для алюминиевой полки с отверстием.</p>				

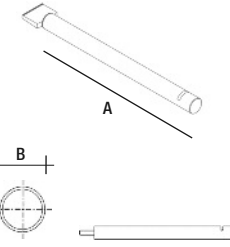
TYPE 36	COD.	A (mm)	B (mm)	KG	★
	IN3601--0000	300	Ø25	0,380	10
<p>Barretta (S8) diritta. Straight hanging bar. Gerade Hängestange. Barre droite. Прямой кронштейн.</p> <p>★ Per ottenere una maggiore portata si consigliano i TYPE 48 e 49. To achieve a higher capacity we recommend you use types 48 and 49. Um eine höhere Tragfähigkeit zu haben, benutzen Sie Typ 48 und 49. Pour obtenir une majeure capacité de charge les types 48 et 49 sont conseillés. Для максимальной грузоподъемности рекомендуется использование TYPE 48 и 49.</p>					

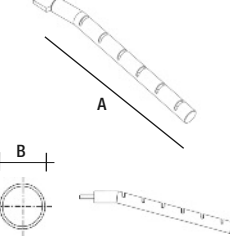
TYPE 37	COD.	A (mm)	B (mm)	KG	★
	IN3701--0000	300	Ø25	0,38	10
<p>Barretta (S8) inclinata. Slanted hanging bar. Schräge Hängestange. Barre inclinée. Наклонный кронштейн.</p> <p>★ Per ottenere una maggiore portata si consigliano i TYPE 48 e 49. To achieve a higher capacity we recommend you use types 48 and 49. Um eine höhere Tragfähigkeit zu haben, benutzen Sie Typ 48 und 49. Pour obtenir une majeure capacité de charge les types 48 et 49 sont conseillés. Для максимальной грузоподъемности рекомендуется использование TYPE 48 и 49.</p>					

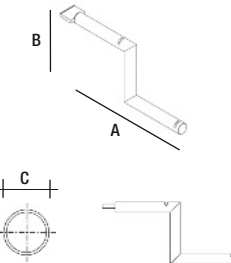
TYPE 38	COD.	A (mm)	B (mm)	C (mm)	KG	★
	IN3801--0000	300	150	Ø25	0,5	10
<p>Barretta (S8) a gradino. Step-shaped hanging bar. Stufenförmige Hängestange. Tige a un marche. Ступенчатый кронштейн.</p> <p>★ Per ottenere una maggiore portata si consigliano i TYPE 48 e 49. To achieve a higher capacity we recommend you use types 48 and 49. Um eine höhere Tragfähigkeit zu haben, benutzen Sie Typ 48 und 49. Pour obtenir une majeure capacité de charge les types 48 et 49 sont conseillés. Для максимальной грузоподъемности рекомендуется использование TYPE 48 и 49.</p>						

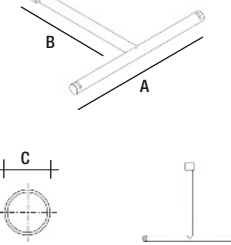
TYPE 39	COD.	A (mm)	B (mm)	C (mm)	KG	★
	IN3901--0000	400	312,5	Ø25	0,79	6
<p>Barretta (S8) a "T". T-shaped hanging bar. T-förmige Hängestange. Barre a "T". "T"-образный кронштейн.</p> <p>★ Per ottenere una maggiore portata si consigliano i TYPE 48 e 49. To achieve a higher capacity we recommend you use types 48 and 49. Um eine höhere Tragfähigkeit zu haben, benutzen Sie Typ 48 und 49. Pour obtenir une majeure capacité de charge les types 48 et 49 sont conseillés. Для максимальной грузоподъемности рекомендуется использование TYPE 48 и 49.</p>						

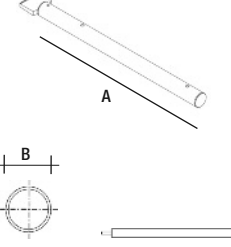
TYPE 40	COD.	A (mm)	B (mm)	KG	★
	IN4001--0000	350	Ø25	0,435	6
<p>Mensola (S8) portaripiani. Shelf-holding bracket. Fachträger. Support pour étagères. Полкодержатель.</p> <p>★ Per ottenere una maggiore portata si consigliano i TYPE 48 e 49. To achieve a higher capacity we recommend you use types 48 and 49. Um eine höhere Tragfähigkeit zu haben, benutzen Sie Typ 48 und 49. Pour obtenir une majeure capacité de charge les types 48 et 49 sont conseillés. Для максимальной грузоподъемности рекомендуется использование TYPE 48 и 49.</p>					

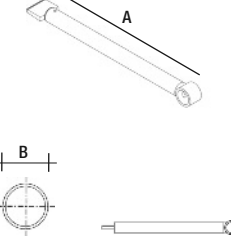
TYPE 41	COD.	A (mm)	B (mm)	KG	★
	IN4101--0000	312,5	Ø25	0,52	6
<p>Mensola (S8) per barra appenderia staccata. Bracket for face-out hanging bar. Fachträger für lose Hängestange. Support pour barre c'accrochage décalée. Держатель для выступающего вешала.</p> <p>★ Per ottenere una maggiore portata si consigliano i TYPE 48 e 49. To achieve a higher capacity we recommend you use types 48 and 49. Um eine höhere Tragfähigkeit zu haben, benutzen Sie Typ 48 und 49. Pour obtenir une majeure capacité de charge les types 48 et 49 sont conseillés. Для максимальной грузоподъемности рекомендуется использование TYPE 48 и 49.</p>					

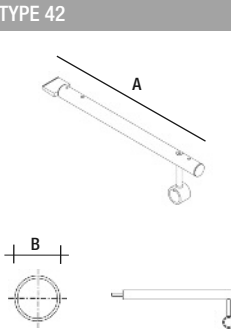
TYPE 42	COD.	A (mm)	B (mm)	KG	★
	IN4201--0000	350	Ø25	0,535	6
<p>Mensola (S8) portaripiani e barra appenderia. Shelf-holding bracket and hanging bar. Fachträger und Hängestange. Support pour étagères et barre d'accrochage. Держатель полки и вешала.</p> <p>★ Per ottenere una maggiore portata si consigliano i TYPE 48 e 49. To achieve a higher capacity we recommend you use types 48 and 49. Um eine höhere Tragfähigkeit zu haben, benutzen Sie Typ 48 und 49. Pour obtenir une majeure capacité de charge les types 48 et 49 sont conseillés. Для максимальной грузоподъемности рекомендуется использование TYPE 48 и 49.</p>					

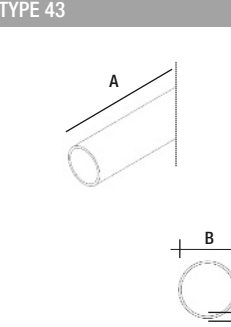
TYPE 43	COD.	A (mm)	B (mm)	C (mm)	KG
	IN4301--0000	3000	Ø25	1,5	2,607
<p>Tubo per appenderia. Tube for hanging bars. Rohr für Hängestange. Tube d'accrochage. ДТруба для вешала.</p>					

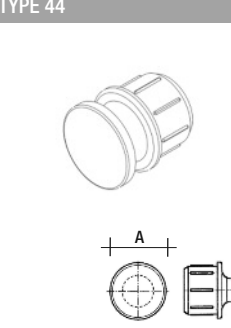
TYPE 44	COD.	A (mm)	KG
	IN4401--0000	Ø25	0,043
<p>Copritesta fermacapo per barra appenderia. End-cap for hanging bar. Endkappe für Hängestange. Bouchon terminal pour barre d'accrochage. Заглушка для вешала.</p>			

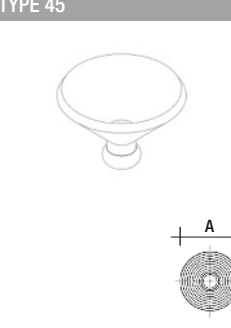
TYPE 45	COD.	A (mm)	KG
	IN4501--0000	Ø23	0,001
<p>Ventosa per ripiani in cristallo. Sucker for crystal shelves. Sauger für Glasfächer. Ventouse pour étagères en cristal. Присоска для стеклянных полок.</p>			

TYPE 46	COD.	A (mm)	B (mm)	KG	★
	IN4601--0000	225	Ø25	0,43	10
<p>Barretta (S8) per ripiano girevole Hanging bar for rotating shelf Hängestange für drehbares Fach Tige pour étagère tournante Кронштейн для вращающейся полки.</p> <p>★ Per ottenere una maggiore portata si consigliano i TYPE 48 e 49. To achieve a higher capacity we recommend you use types 48 and 49. Um eine höhere Tragfähigkeit zu haben, benutzen Sie Typ 48 und 49. Pour obtenir une majeure capacité de charge les types 48 et 49 sont conseillés. Для максимальной грузоподъемности рекомендуется использование TYPE 48 и 49.</p>					

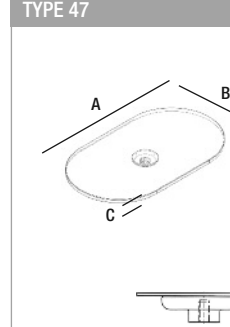
TYPE 47	COD.	A (mm)	B (mm)	C (mm)	KG	★
	IN4701--0000	340	200	8	1,526	10
<p>Ripiano ovale girevole in cristallo Rotating oval crystal shelf Drehbares ovalförmiges Glasfach Étagère ovale tournant en cristal Овальная вращающаяся стеклянная полка.</p> <p>★ Per ottenere una maggiore portata si consigliano i TYPE 48 e 49. To achieve a higher capacity we recommend you use types 48 and 49. Um eine höhere Tragfähigkeit zu haben, benutzen Sie Typ 48 und 49. Pour obtenir une majeure capacité de charge les types 48 et 49 sont conseillés. Для максимальной грузоподъемности рекомендуется использование TYPE 48 и 49.</p>						

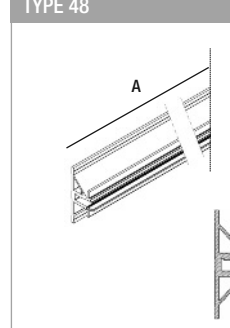
TYPE 48	COD.	A (mm)	KG
	IN4801--0000	1200	2,085
	IN4802--0000	1800	3,128
	IN4803--0000	6100	10,60
<p>Profilo forte (S8) per legno - legno. Strong Joint profile for wooden - wooden panels. Starkes Profil zwischen Holzpaneel und Holzpaneel. Profil résistant pour panneaux en bois - bois. Усиленный профиль (S8) для дерева - дерево.</p>			

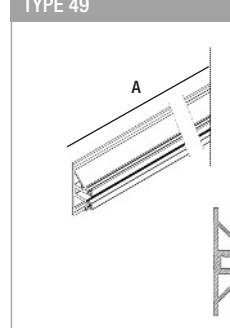
TYPE 49	COD.	A (mm)	KG
	IN4901--0000	1200	2,15
	IN4902--0000	1800	3,225
	IN4903--0000	6100	10,93
<p>Profilo forte (S8) per vetro - vetro. Strong Joint profile for glass - glass panels. Starkes Profil zwischen Glaspaneel und Glaspaneel. Profil résistant pour verre - panneau en verre. Усиленный профиль (S8) для стекла - стекло.</p>			

TYPE 50

COD.	A (mm)	KG
IN5001--0000	1200	2,384
IN5002--0000	1800	3,576
IN5003--0000	6100	12,12

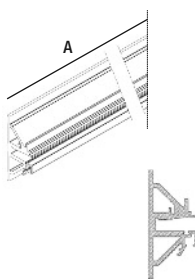

Profilo forte (S8) per vetro - legno.
 Strong joint profile for glass - wooden panels.
 Starkes Profil zwischen Glaspaneel und Holzpaneel.
 Profil résistant (S8) pour panneau en verre - bois.
 Усиленный профиль (S8) стекло - дерево.

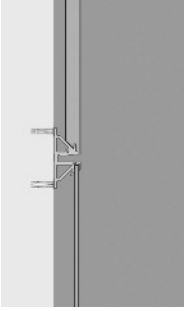

TYPE 51

COD.	A (mm)	KG
IN5101--0000	1200	2,314
IN5102--0000	1800	3,472
IN5103--0000	6100	11,77

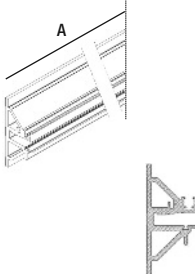

Profilo forte (S8) per legno - vetro.
 Strong joint profile for wooden - glass panels.
 Starkes Profil zwischen Holzpaneel und Glaspaneel.
 Profil résistant (S8) pour panneau en bois - verre.
 Усиленный профиль (S8) дерево - стекло.

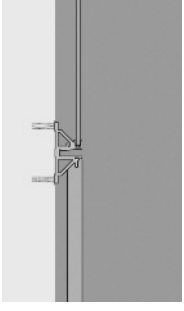

STRUTTURA A PARETE WALL STRUCTURE

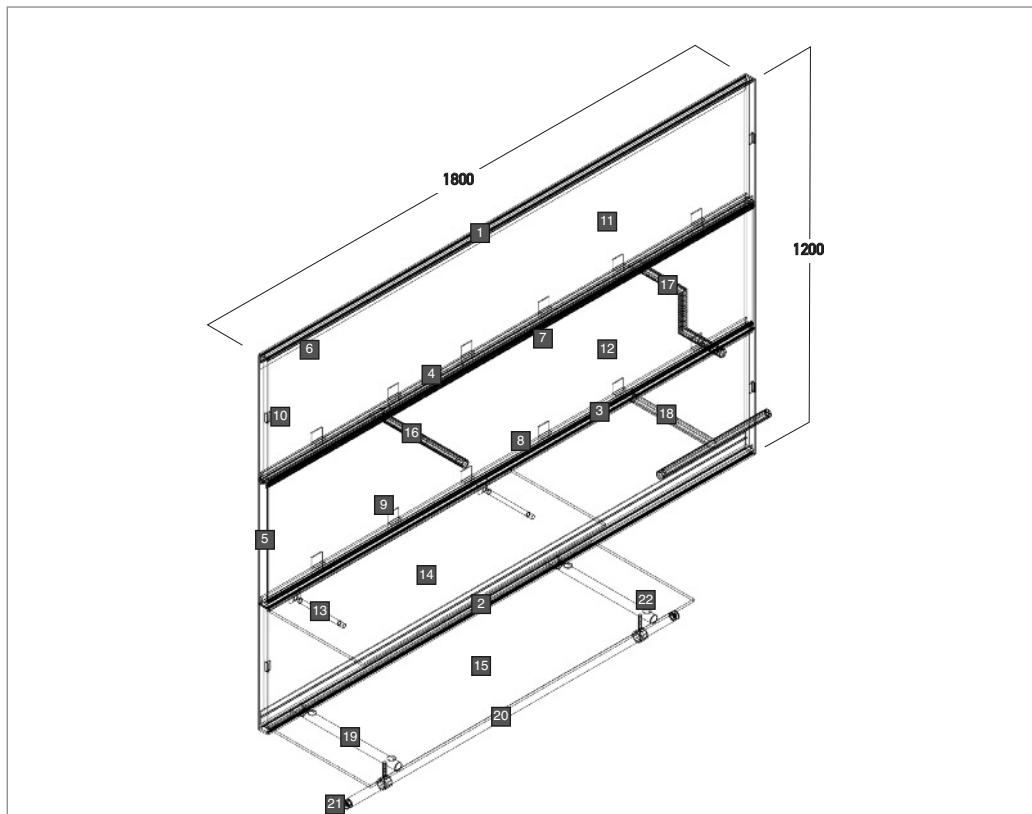

POS	SYSTEM	TYPE	A (mm)	B (mm)	C (mm)	PCS
1	INFINITY	1	1800			1
2	INFINITY	4	1800			1
3	INFINITY	6	1800			1
4	INFINITY	7	1800			1
5	INFINITY	8	3000			1
6	INFINITY	9	1800			1
7	INFINITY	11	1000			6
8	INFINITY	12	2650			2
9	INFINITY	13	40			12
10	INFINITY	14	30			4
11	INFINITY	15	1800	387	19	2
12	INFINITY	16	1800	380	4	1
13	INFINITY	24	180			1
14	INFINITY	30	900	380	8	1
15	INFINITY	31	1200	380	8	1
16	INFINITY	36	300			1
17	INFINITY	38	300	150		1
18	INFINITY	39	400	312,5		1
19	INFINITY	42	350	Ø25		2
20	INFINITY	43	3000	Ø25		1
21	INFINITY	44	Ø25			2
22	INFINITY	45	Ø25			4

STRUTTURA A PARETE WALL STRUCTURE

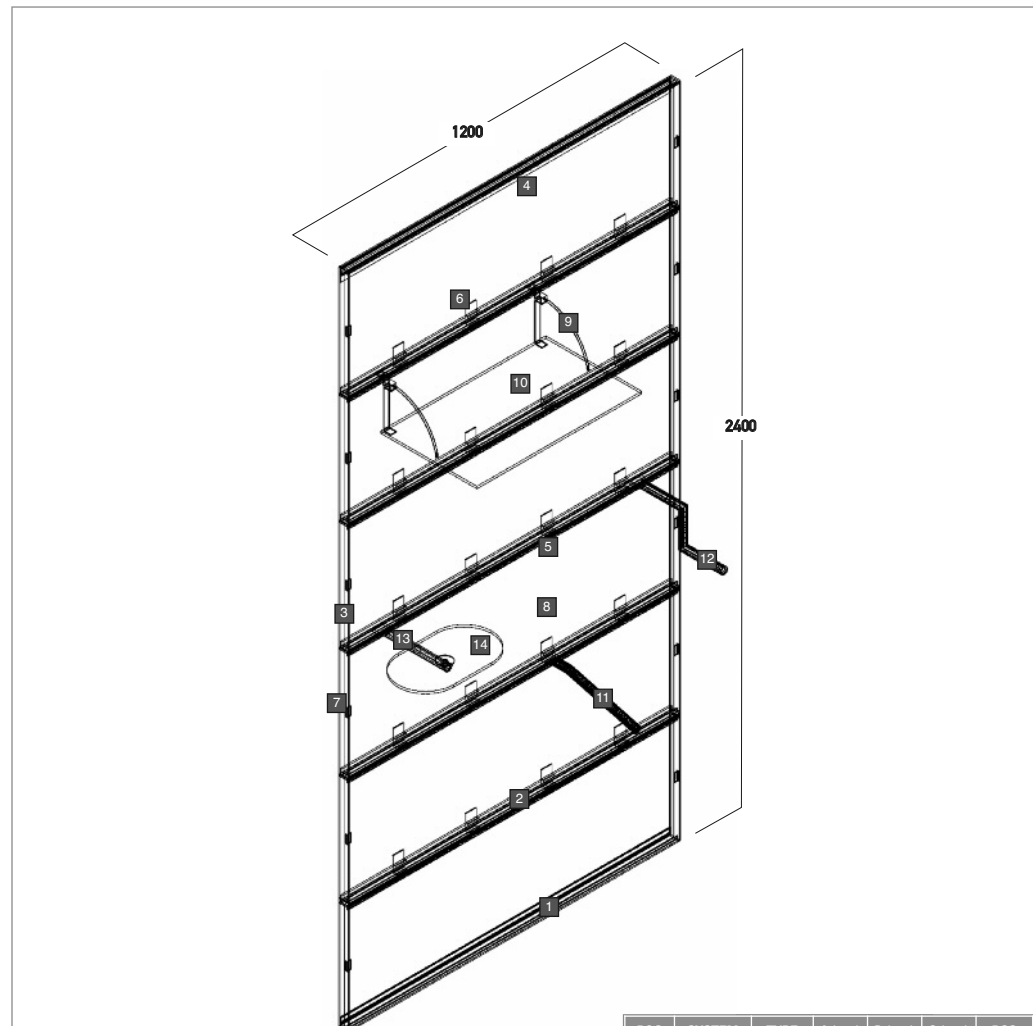

POS	SYSTEM	TYPE	A (mm)	B (mm)	C (mm)	PCS
1	INFINITY	1	1200			2
2	INFINITY	2	1200			5
3	INFINITY	8	3000			2
4	INFINITY	9	1200			1
5	INFINITY	11	1000			6
6	INFINITY	13	40			20
7	INFINITY	14	30			12
8	INFINITY	15	1200	387	19	6
9	INFINITY	26	147,5			1
10	INFINITY	29	600	350	8	1
11	INFINITY	37	300			1
12	INFINITY	38	300	150		1
13	INFINITY	46	225			1
14	INFINITY	47	340	200	8	1

MONTAGGIO PANNELLI - PROFILI TP 2-5-6-7 PANELS ASSEMBLY - PROFILES TP 2-5-6-7

POSSIBILI SITUAZIONI DI CHIUSURA SUPERIORE PANNELLATURA.
SOLUTION OF UPPER PANEL CLOSURE.

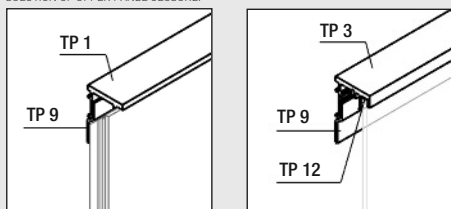

POSSIBILI SITUAZIONI INTERMEDIE.
INTERMEDIATE SOLUTION.

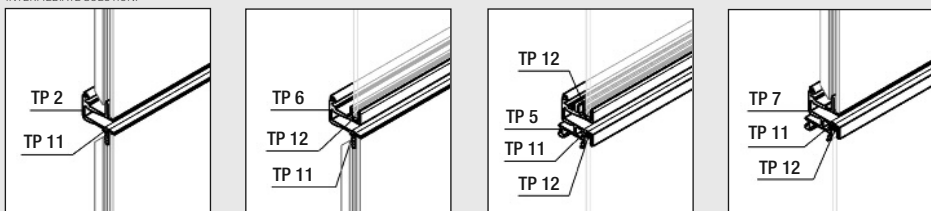

POSSIBILI SITUAZIONI DI INIZIO PANNELLATURA.
SOLUTION OF STARTING PANEL.

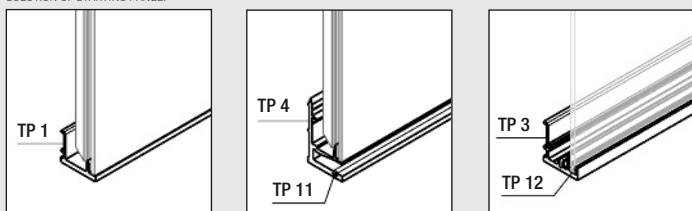

CHIUSURA LATERALE.
SIDE CLOSURE.

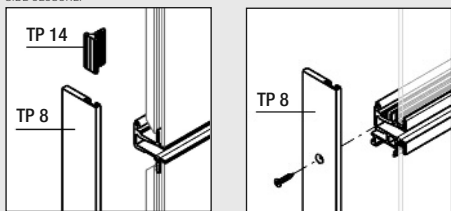

SEZIONE ORIZZONTALE.
HORIZONTAL SECTION.

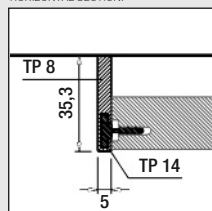

PARTICOLARE STAFFA DI FISSAGGIO (TP 13).
DETAILS OF FIXING BRACKET (TP 13).

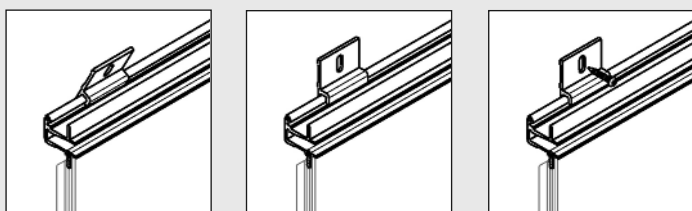

MONTAGGIO PANNELLI A PARETE PANEL WALL ASSEMBLY DRAWING



SCHEMA PER FORATURA PROFILO TYPE 8
(UTILIZZO CON PANNELLI IN CRISTALLO)
DRAWING FOR THE PROFILE TYPE 8 DRILLING
(TO BE USED WITH GLASS PANELS)

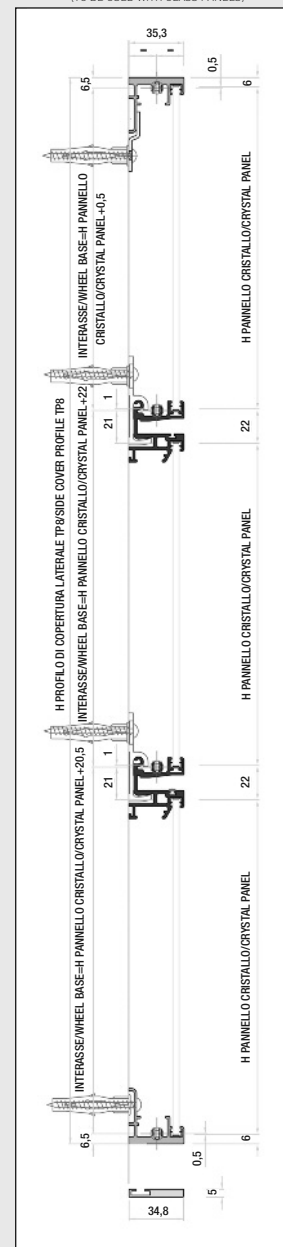

- 1 PROFILO DI PARTENZA FISSATO A MURO E DI CHIUSURA SUPERIORE PANNELLATURA.
STARTING AND UPPER PANEL CLOSURE PROFILE FIXED TO THE WALL.
- 2 PROFILO (TP 9) FISSATO A MURO PER L'AGGANCIAMENTO DELL'ULTIMO PANNELLO.
PROFILE (TP 9) FIXED TO THE WALL FOR FASTENING OF LAST PANEL.
- 3 PROFILI ORIZZONTALI CON GUARNIZIONE ANTISCIVOLAMENTO.
PROFILES WITH HORIZONTAL ANTISKID GASKET.
- 4 STAFFA (TP 13) FISSATA A MURO, DI SOSTEGNO E BLOCCAGGIO DEL PROFILO ORIZZONTALE.
(n°4 FINO A L=1200, n°6 FINO A L=1800).
BRACKET (TP 13) FIXED TO THE WALL FOR SUPPORT AND LOCKING OF HORIZONTAL PROFILE
(n°4 PCS, UP TO 1200 MM LENGTH, n°6 PCS, UP TO 1200 MM LENGTH).
- 5 PROFILO (TP 8) COPERTURA LATERALE.
SIDE COVER PROFILE (TP 8).
- 6 GIUNTO (TP 14) DI COLLEGAMENTO COPERTURA LATERALE (1 PER OGNI PANNELLO).
POSIZIONABILE LIBERAMENTE NEL PROFILO TP 8.
CONNECTING JOINT (TP 14) OF SIDE COVER (1) FOR EACH PANEL.
TO BE POSITIONED FREELY IN PROFILE TP 8.

STRUTTURA A PARETE WALL STRUCTURE

POS	SYSTEM	TYPE	A (mm)	B (mm)	C (mm)	PCS
1	INFINITY	3	1800			2
2	INFINITY	8	3000			2
3	INFINITY	9	1800			1
4	INFINITY	11	1000			6
5	INFINITY	12	2650			3
6	INFINITY	14	30			4
7	INFINITY	15	1800	387	19	2
8	INFINITY	16	1800	380	4	2
9	INFINITY	19	600	150	7,7	1
10	INFINITY	20	100			2
11	INFINITY	31	900	380	8	1
12	INFINITY	33	600	425	8	1
13	INFINITY	34	540	27		1
14	INFINITY	37	300	Ø25		1
15	INFINITY	42	350	Ø25		1
16	INFINITY	43	3000	Ø25		1
17	INFINITY	44		Ø25		2
18	INFINITY	45		Ø23		4
19	INFINITY	48	1800			1
20	INFINITY	50	1800			1
21	INFINITY	51	1800			1

STRUTTURA A PARETE WALL STRUCTURE

POS	SYSTEM	TYPE	A (mm)	B (mm)	C (mm)	PCS
1	INFINITY	1	1200			1
2	INFINITY	3	1200			1
3	INFINITY	8	3000			2
4	INFINITY	9	1200			1
5	INFINITY	11	1000			6
6	INFINITY	12	2650			3
7	INFINITY	14	30			6
8	INFINITY	15	1200	387	19	3
9	INFINITY	16	1200	380	4	3
10	INFINITY	24	180			2
11	INFINITY	30	1200	380	8	2
12	INFINITY	37	300	Ø25		1
13	INFINITY	38	300	150	Ø25	2
14	INFINITY	46	300	Ø25		2
15	INFINITY	47	340	200	8	2
16	INFINITY	48	1200			2
17	INFINITY	49	1200			2
18	INFINITY	51	1200			1

MONTAGGIO PANNELLI - PROFILI FORTI TP 48-49-50-51 PANELS ASSEMBLY - STRONG PROFILES TP 48-49-50-51

POSSIBILI SITUAZIONI DI CHIUSURA SUPERIORE PANNELLATURA.
SOLUTION OF UPPER PANEL CLOSURE.

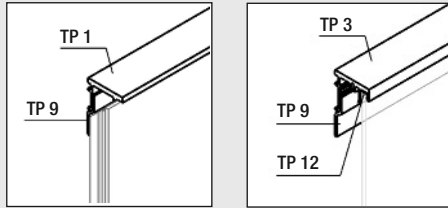

POSSIBILI SITUAZIONI INTERMEDIE.
INTERMEDIATE SOLUTION.

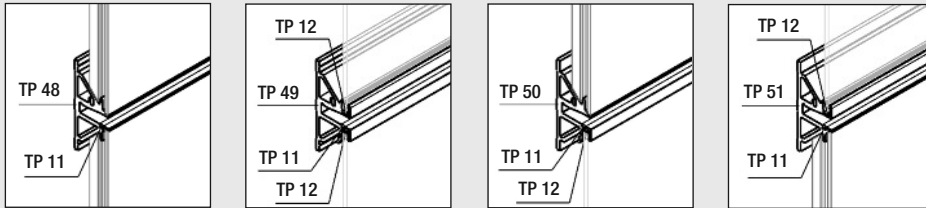

POSSIBILI SITUAZIONI DI INIZIO PANNELLATURA.
SOLUTION OF STARTING PANEL.

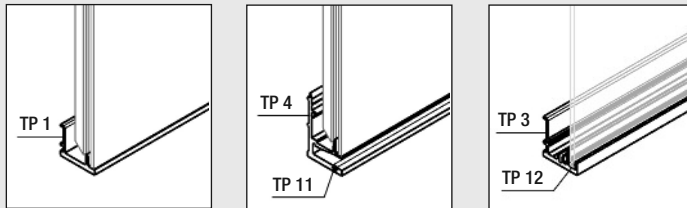

CHIUSURA LATERALE.
SIDE CLOSURE.

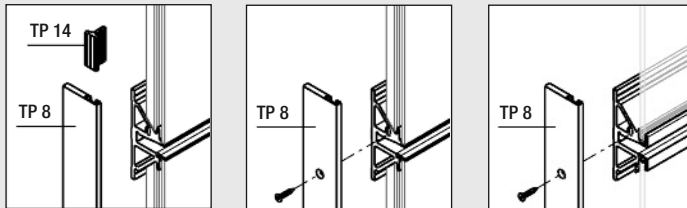

SEZIONE ORIZZONTALE.
HORIZONTAL SECTION.

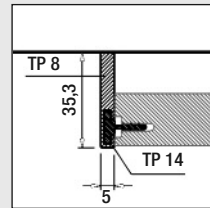

PARTICOLARE FISSAGGIO A PARETE CON PROFILI FORTI.
DETAILS OF WALL FASTENING WITH STRONG PROFILES.

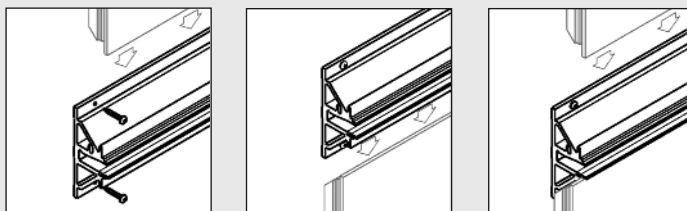

artheta[®]
IIII GROUP

ARTHEMAGROUP s.r.l.

Via Cascina Restelli, 5 - 20040 Aicurzio (MB) Italy

Tel. +39 0396093099 - Fax +39 0396093307

arthemagroup@arthemagroup.it - www.arthemagroup.it