

arthema<sup>®</sup>  
SYSTEM  
Catalogo Tecnico 2009 .1

Gentile Cliente, per una facile lettura del catalogo, Vi invitiamo a consultare questa legenda.  
 Dear Customer, please read the following guidelines for a better understanding of our catalogue.  
 Sehr geehrter Kunde, bitte lesen Sie die folgenden Zeichenerklärungen für ein besseres Verständnis unseres Katalogs.  
 Cher client, pour simplifier la lecture du catalogue, Vous pouvez consulter cette légende.  
 Уважаемый клиент, для лучшего понимания Каталога предлагаем Вам прочесть данное толкование.

TYPE 20	COD.	A (mm)	B (mm)	KG	h
	AL2001--0000	600	350	0,89	40
	AL2002--0000	900	350	1,32	35

7 Barra appenderia staccata.  
 Outdistanced hanging bar.  
 Lose Abhängestange.  
 Barre d'accrochage décalée.  
 Выступающее вешало.

① **Immagine prodotto - Item picture - Abbildung artikel - Image produit - Изображение артикула**

In questa casella è riportata un'immagine indicativa del prodotto non imballato; si precisa che tale immagine è da considerarsi come una rappresentazione grafica non vincolante ai fini delle caratteristiche tecniche del prodotto.  
 This box contains a picture of the unpacked article. This picture is just as an indication, and it is therefore meant as a graphic representation, which is not as worth as a technical report.  
 Auf diesem Kästchen steht eine Abbildung des unverpackten Artikels. Diese Abbildung gilt sowieso nur als eine graphische Darstellung, die nicht verbindlich als technische Daten zu betrachten ist.  
 Ici Vous verrez une image du produit pas emballé. Cette image devra être considérée seulement comme une représentation graphique pas liée aux caractéristiques techniques du produit.  
 В данной графе приводится изображение изделия без упаковки; уточняем, что данный рисунок является условным изображением, не связанным с техническими характеристиками изделия.

② **Codice prodotto - Item code - Kode Artikel - Code produit - Код артикул**

●(A) Il codice articolo è composto da 12 caratteri alfanumerici e deve essere utilizzato per meglio indicare il materiale da ordinare.  
 The item code is composed of 12 alphanumeric types and should be used to mark the ordered material.  
 Der Artikelcode besteht aus 12 alphanumerischen Schriftzeichen und muss zur genauen Beschreibung der bestellten Produkten benutzt werden.  
 Le code article est composé par 12 caractères alfa-numériques et doit être utilisé pour mieux indiquer le matériel qu'on désire acheter.  
 Код артикула состоит из 12 знаков и используется для наилучшего указания изделия в заказе.

●(B) Le due cifre inserite in questa posizione indicano la tipologia di finitura del prodotto.  
 The two digits in this position stand for the type of finish.  
 Die zwei Zahlen auf dieser Stelle kennzeichnen die Ausführung des Artikels.  
 Les deux chiffres qui se trouvent ici indiquent la finition de l'article.  
 Две цифры в данном расположении указывают тип отделки изделия.

③ **Misure prodotto - Item sizes- Maß artikel - Mesure produit - Размеры артикула**

④ **Peso prodotto - Item weight - Gewicht des Artikels - Poids produit - Вес артикула**

In questa casella è indicato il peso del prodotto non imballato espresso in chilogrammi.  
 This box indicates the weight of an unpacked item in kilograms.  
 Auf diesem Kästchen steht das Gewicht eines unverpackten Artikels in Kg.  
 Dans cette boîte est indiqué le poids du produit déballé en Kilos.  
 В этой графе указан вес артикула, выраженный в кг. без упаковки.

⑤ **Portata prodotto - Capacity - Tragfähigkeit - Portée du produit - Максимальная нагрузка**

Espressa in Kg. essa si riferisce al peso massimo sopportabile ed equamente distribuito. La portata del prodotto è da ritenersi comunque indicativa e non vincolante per Arthemagroup, che non si assume alcuna responsabilità circa il non corretto utilizzo del prodotto venduto.  
 The capacity, indicated in kilograms, refers to the maximum weight evenly distributed that an item can accommodate. The stated capacity is indicative and non-binding for Arthemagroup, which shall not be held responsible for any damage resulting from an improper use of any sold item.  
 Die Tragfähigkeit – hier in Kilogram – bezieht sich auf das maximale, gleich verteilte Gewicht, dass ein Artikel tragen kann. Die Tragfähigkeit versteht sich als eine nicht verbindliche Richtangabe und Arthemagroup haftet nicht für Schaden, die bei einer unrichtigen Benutzung des verkauften Produkts entstehen.  
 La portée du produit est indiquée en kilos. Elle se réfère au poids maximum et distribué en parts égales que le produit peut soutenir. Elle est toutefois approximative et pas contraignante pour Arthemagroup qui n'a aucune responsabilité sur l'usage pas correct du produit une fois il est vendu.  
 Выраженная в кг, обозначает максимальный вес равномерно распределенного товара. Просьба учесть тот факт, что этот показатель довольно относительная величина и Arthemagroup не берет на себя никакой ответственности за некорректное использование проданного материала.

⑥ **Uso prodotto - Usage of the product - Benutzung des Produkts - Usage du produit - Использование продукции**

In questa casella è indicato il corretto uso del prodotto sul sistema di riferimento.  
 This box explains how to use correctly the product on its system.  
 Auf diesem Kästchen steht die korrekte Benutzung des Produkts auf das System.  
 Dans cette boîte est indiqué l'usage correct du produit sur le système dont il fait partie.  
 В этой графе приведены советы о правильном использовании соответствующих систем.

⑦ **Descrizione tecnica del prodotto - Technical description of the item - Technische Daten des Artikels - Description technique de l'article - Техническое описание артикула**

In questa casella è riportato il TYPE del prodotto ed anche una breve DESCRIZIONE dello stesso. Occasionalmente è possibile trovare anche la dicitura "F.S." seguita da un numero/signa che rappresenta la sola finitura di serie per quel type.  
 Here you can find the Type of the item and a brief description of it. Occasionally it's possible to find the inscription "S.F" as well followed by a number/mark representing the only standard finishing for that type.  
 Auf diesem Kästchen wird der Artikeltyp mit dessen kurzer Beschreibung eingeführt. Eventuell erscheint die Abkürzung "S.F." auch vor einer Anzahl/Kennwort. Diese Anzahl stellt die einzige Standardausführung für diesen Typ dar.  
 Ici Vous trouverez le TYPE du produit et aussi une brève description du même. De temps en temps il est possible de trouver la forme "F.S." aussi, suivie d'un nombre/signa qui représente la seule finition de série pour ce type-là.  
 В данной графе указывается ТИП артикула, а также его краткое описание. Иногда можно увидеть надпись "С.О.", за которой следуют другие сокращения, которые означают единственные возможные серийные отделки для данного типа.

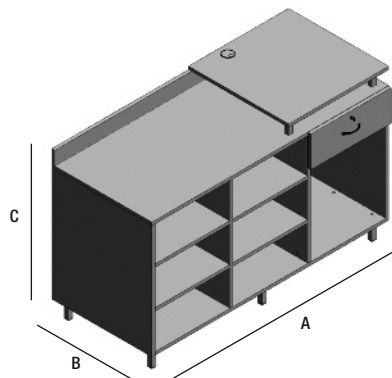
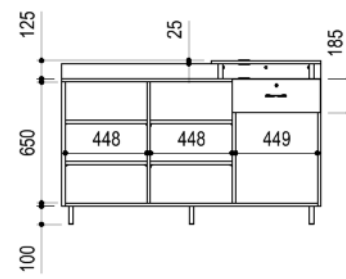

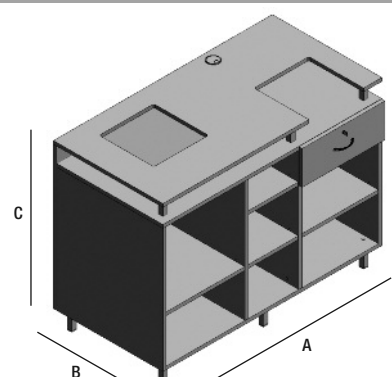
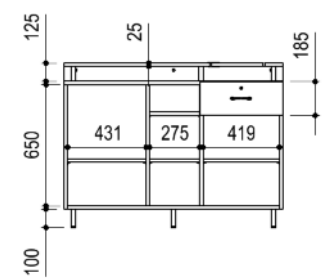
TYPE 1	COD.	A (mm)	B (mm)	C (mm)	KG
	ML0101----00	1420	600	900	79,3
	<p>Banco cassa con top, cassetto e vani a giorno.                      Cash register counter with top, drawer and open compartments.                      Ladentheke mit Deckplatte, Schublade und offenen Fächern.                      Comptoir avec sommet, tiroir et pièces à claire-voie.                      Прилавок с верхней крышкой, выдвижным ящиком и открытыми нишами.</p>				
					

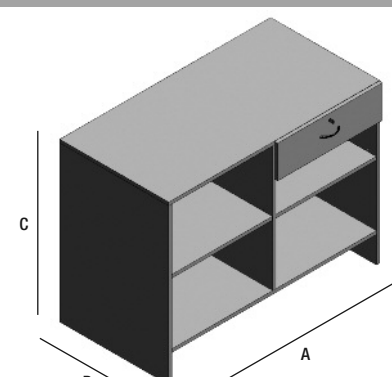
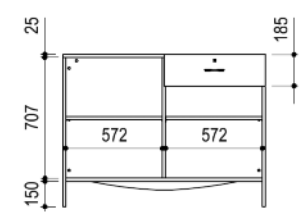
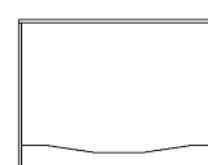
TYPE 2	COD.	A (mm)	B (mm)	C (mm)	KG
	ML0201-----	1200	600	900	77,1
	<p>Banco cassa con top, cassetto e vani a giorno.                      Cash register counter with top, drawer and open compartments.                      Ladentheke mit Deckplatte, Schublade und offenen Fächern.                      Comptoir avec sommet, tiroir et pièces à claire-voie.                      Прилавок с верхней крышкой, выдвижным ящиком и открытыми нишами.</p>				
					

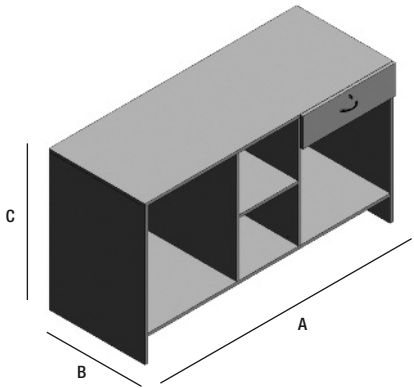
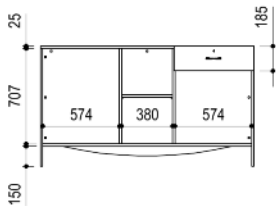
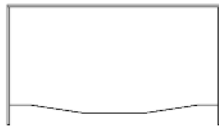
TYPE 3	COD.	A (mm)	B (mm)	C (mm)	KG
	ML0301--0000	1200	600	900	68,9
	<p>Banco cassa con schienale sagomato, cassetto e vani a giorno.                      Cash register counter with shaped back, drawer and open compartments.                      Ladentheke mit geformter Rückseite, Schublade und offenen Fächern.                      Comptoir avec dossier modelé, tiroir et pièces à claire-voie.                      Прилавок с фигурной спинкой, выдвижным ящиком и открытыми нишами.</p>				
					
					

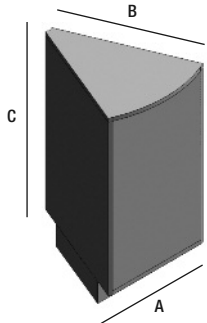
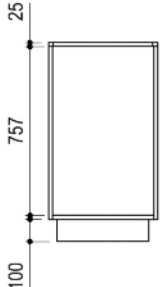
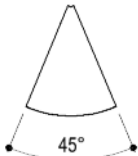
TYPE 4	COD.	A (mm)	B (mm)	C (mm)	KG
	ML0401--0000	1600	600	900	74,4
	<p>Banco cassa con schienale sagomato, cassetto e vani a giorno.                      Cash register counter with shaped back, drawer and open compartments.                      Ladentheke mit geformter Rückseite, Schublade und offenen Fächern.                      Comptoir avec dossier modelé, tiroir et pièces à claire-voie.                      Прилавок с фигурной спинкой, выдвижным ящиком и открытыми нишами.</p>				
					
					

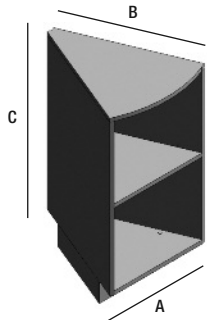
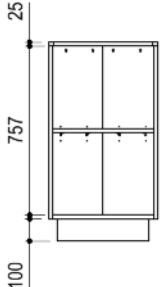
TYPE 50	COD.	A (mm)	B (mm)	C (mm)	KG
	ML5001--0000	495	600	900	25,1
	<p>Banco angolare chiuso.                      Closed corner counter.                      Geschlossene Eck-Theke.                      Comptoir angulaire fermé.                      Угловой закрытый прилавок.</p>				
					
					

TYPE 51	COD.	A (mm)	B (mm)	C (mm)	KG
	ML5101--0000	495	600	900	23,8
	<p>Banco angolare con vani a giorno.                      Corner counter with open compartments.                      Eck-Theke mit offenen Fächern.                      Comptoir angulaire avec pièces à claire-voie.                      Угловой прилавок с открытыми нишами.</p>				
					
					

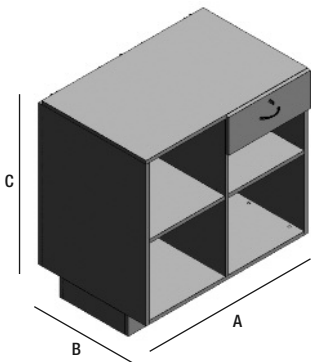
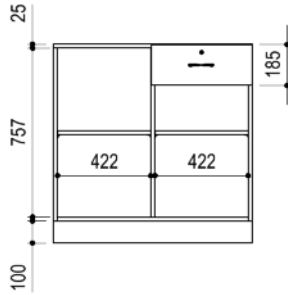
TYPE 52	COD.	A (mm)	B (mm)	C (mm)	KG
	ML5201--0000	900	600	900	54,9
	<p>Banco con 1 cassetto dx e vani a giorno.                      Cash register counter with one drawer on the right and open compartments.                      Ladentheke mit einer Schublade rechts und offenen Fächern.                      Comptoir avec un tiroir droit et pièces à claire-voie.                      Прилавок с правым ящиком и открытыми нишами.</p>				
					

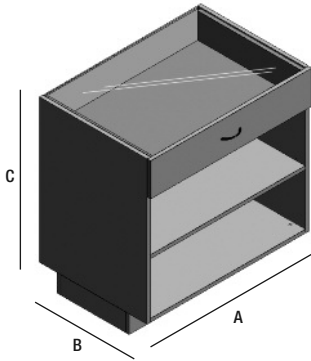
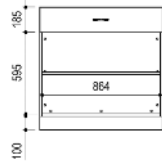
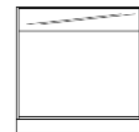
TYPE 53	COD.	A (mm)	B (mm)	C (mm)	KG
	ML5301----00	900	600	900	60,1
	<p>Banco con top cassetto vetrina e vani a giorno.                      Counter with top glass drawer and open compartments.                      Vitrinentheke mit Schublade mit Glasplatte und offenen Fächern.                      Comptoir avec vitrine au sommet et pièces à claire-voie.                      Прилавок с ящиком витриной и открытыми нишами.</p>				
	 				

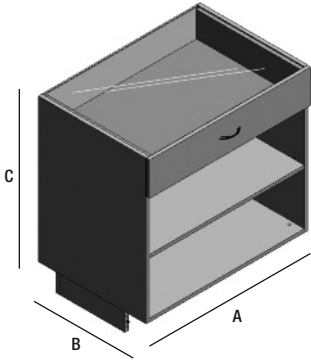
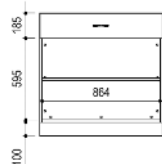
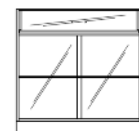
TYPE 54	COD.	A (mm)	B (mm)	C (mm)	KG
	ML5401----00	900	600	900	69,0
	<p>Banco con top cassetto vetrina, vani a giorno e frontale con vetri scorrevoli.                      Counter with top glass drawer, open compartments and front side with sliding glass doors.                      Vitrinentheke mit Schublade mit Glasplatte, offenen Fächern und Front mit Glas-Schiebetüren.                      Comptoir avec vitrine au sommet, pièces à claire-voie et pièce frontale avec verres coulissants.                      Прилавок с ящиком витриной, открытыми нишами и раздвижными стеклами.</p>				
	 				

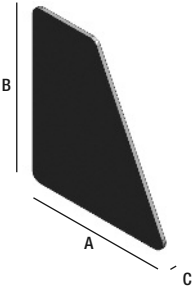
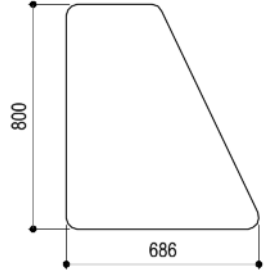
TYPE 55	COD.	A (mm)	B (mm)	C (mm)	KG
	ML5501--0000	758	800	18	9,0
	<p>Spalla sagomata terminale. Shaped end side. Geformte Endseite. Epaule modelé terminale. Фигурная боковая часть.</p>				
					

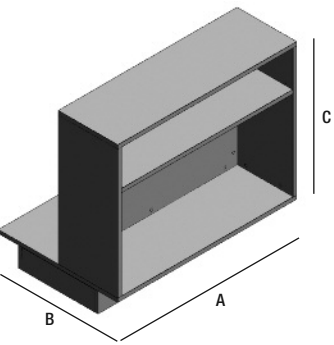
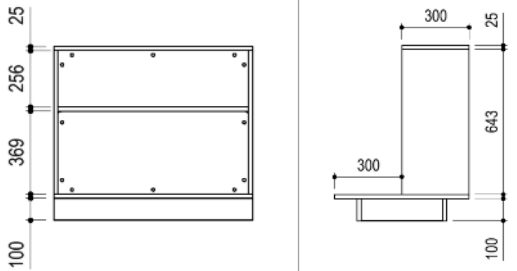
TYPE 56	COD.	A (mm)	B (mm)	C (mm)	KG
	ML5601--0000	900	600	786	31,0
	<p>Banco con frontale dogato. Cash register counter with slatted front. Ladentheke mit Lamellen an der Vorderseite. Comptoir avec pièce frontale avec douves. Прилавок с экономпанелью в торцевой части.</p>				
					

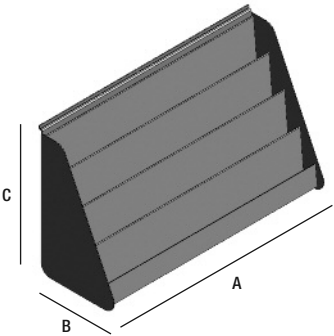
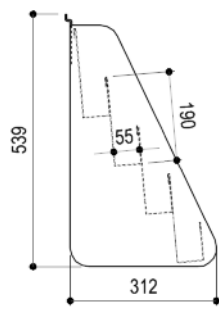
TYPE 57	COD.	A (mm)	B (mm)	C (mm)	KG
	ML5701--0000	900	370	600	13,4
	<p>Portariviste per banco con frontale dogato. Counter magazine rack with slatted front. Zeitschriftentheke mit Lamellen an der Vorderseite. Porte-dépliant pour comptoir avec pièce frontale avec douves. Журнальный столик для прилавка с экономпанелью.</p>				
					

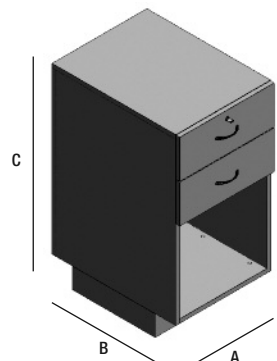
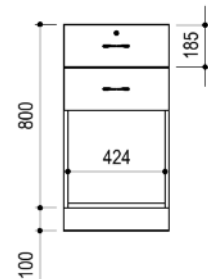
TYPE 58	COD.	A (mm)	B (mm)	C (mm)	KG
	ML5801--0000	460	600	900	34,3
	<p>Banco con 2 cassetti e vano a giorno.                      Cash register counter with two drawers and an open compartment.                      Ladentheke mit zwei Schubladen und einem offenen Fach.                      Comptoir avec 2 tiroirs et pièce à claire-voie.                      Прилавок с двумя выдвигаемыми ящиками и открытой нишей.</p>				
					

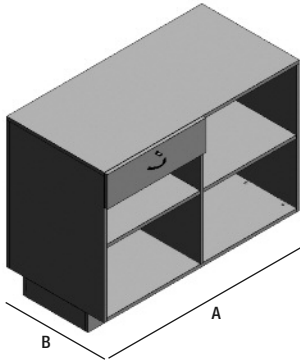
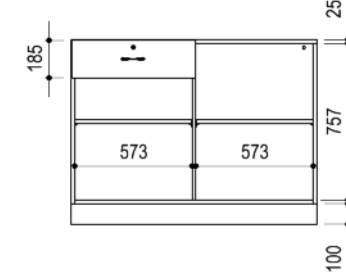
TYPE 59	COD.	A (mm)	B (mm)	C (mm)	KG
	ML5901--0000	1200	600	900	66,5
	<p>Banco con 1 cassetto sinistro e vani giorno.                      Cash register counter with one drawer on the left and open compartments.                      Ladentheke mit einer Schublade links und offenen Fächern.                      Comptoir avec un tiroir gauche et pièces à claire-voie.                      Прилавок с одним левым ящиком и открытыми нишами.</p>				
					

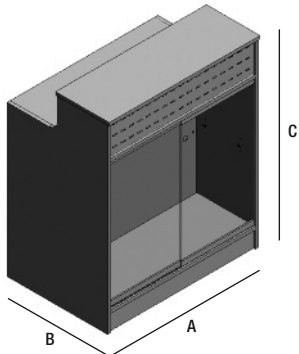
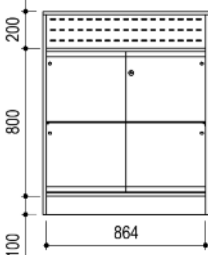
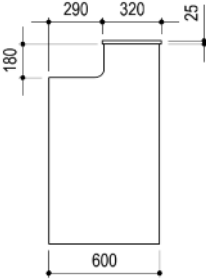

TYPE 100	COD.	A (mm)	B (mm)	C (mm)	KG
	ML100A----00	600	600	1100	38,0
	<p>Modulo banco semicircolare con frontale curvo in metallo.                      Semi-circular counter with a bended metal front.                      Halbrunde Theke mit gebogener Front aus Metall.                      Comptoir semi-circulaire avec pièce frontale courbe en métal.                      Модуль полукруглого прилавка с закругленным металлическим торцом.</p>				
	 				

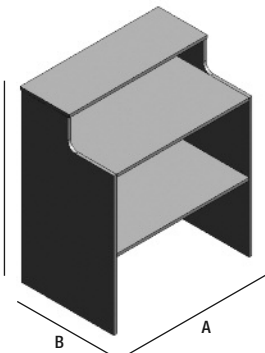
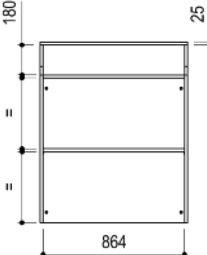
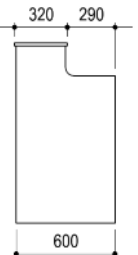

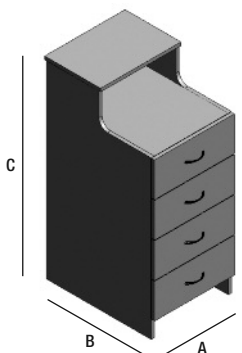
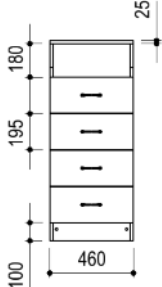
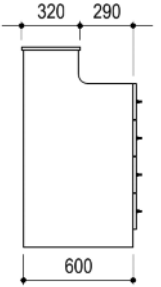
TYPE 101	COD.	A (mm)	B (mm)	C (mm)	KG
	ML101A-----	900	600	1100	42,4
<p>Modulo banco con spalla a "L", frontalino in metallo e vetrina.                      Counter with L-shaped sides, metal decoration and showcase.                      Theke mit L-förmigen Seiten, Metalldekoration und Vitrine.                      Comptoir avec épaule à "L", décoration en métal et vitrine.                      Модуль прилавка со спинкой в форме L, с фронтальной металлической панелькой и витриной.</p>					
					

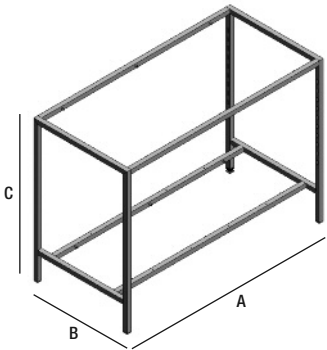
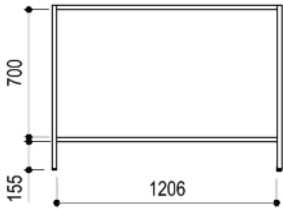

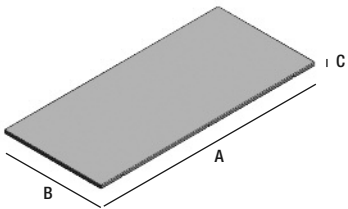
TYPE 102	COD.	A (mm)	B (mm)	C (mm)	KG
	ML102A----00	900	600	1100	42,4
<p>Modulo banco con spalle a "L" e frontalino in metallo.                      Counter with L-shaped sides and metal decoration.                      Theke mit L-förmigen Seiten und Metalldekoration.                      Comptoir avec épaule à "L" et décoration en métal.                      Модуль прилавка со спинкой в форме L и фронтальной металлической панелькой.</p>					
					

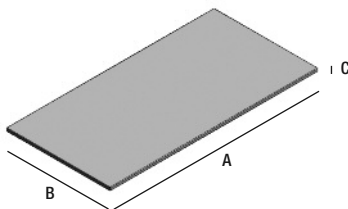

TYPE 103	COD.	A (mm)	B (mm)	C (mm)	KG
	ML103A----00	460	600	1100	44,0
<p>Modulo cassetiera a 4 cassetti con spalle a "L" e frontalino in metallo.                      Four drawer unit with L-shaped sides and metal decoration.                      Theke mit 4 Schubladen, L-förmigen Seiten und Metalldekoration.                      Comptoir avec 4 tiroirs, épaules à "L" et décoration en métal.                      Тумбочка с 4 выдвижными ящиками, спинкой в форме L и фронтальной металлической панелькой.</p>					
					

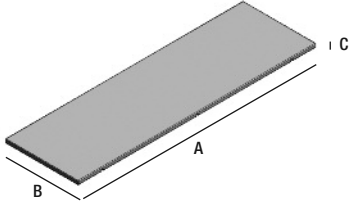

TYPE 150	COD.	A (mm)	B (mm)	C (mm)	KG
	<b>ML150A--0000</b>	1260	600	900	18,0
<p>Telaio per tavolo. Table frame. Tischrahmen. Chassis pour table. Каркас для стола.</p>					

TYPE 151	COD.	A (mm)	B (mm)	C (mm)	KG
	<b>ML151A--0000</b>	1205	545	18	7,95
<p>Ripiano top in legno per tavolo. Upper wooden shelf for table. Oberer Holzboden für Tisch. Étagère supérieure en bois pour table. Столешница деревянная.</p>					

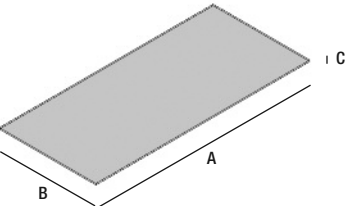
TYPE 152	COD.	A (mm)	B (mm)	C (mm)	KG
	<b>ML152A--0000</b>	1205	600	18	8,75
<p>Ripiano intermedio in legno per tavolo. Middle wooden shelf for table. Mittlerer Holzboden für Tisch. Étagère intermédiaire en bois pour table. Средняя деревянная полка для стола.</p>					

TYPE 153	COD.	A (mm)	B (mm)	C (mm)	KG
	<b>ML153A--0000</b>	1205	370	18	5,4
	<p>Ripiano basso in legno per tavolo.                      Lower wooden shelf for table.                      Niedriger Holzboden für Tisch.                      Étagère inférieure en bois pour table.                      Нижняя деревянная полка для стола.</p>				
					

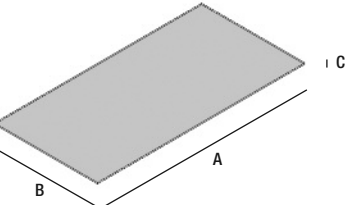
TYPE 154	COD.	A (mm)	B (mm)	C (mm)	KG
	<b>ML154A--0000</b>	1205	545	8	13,4
	<p>Ripiano top in cristallo per tavolo.                      Upper crystal shelf for table.                      Oberer Glasfachboden für Tisch.                      Étagère supérieur en cristal pour table.                      Столешница стеклянная.</p>				
					

TYPE 155	COD.	A (mm)	B (mm)	C (mm)	KG
	<b>ML155A--0000</b>	1205	600	8	14,7
	<p>Ripiano intermedio in cristallo per tavolo.                      Middle crystal shelf for table.                      Mittlerer Glasfachboden für Tisch.                      Étagère intermédiaire en cristal pour table.                      Средняя стеклянная полка для стола.</p>				
					

TYPE 156	COD.	A (mm)	B (mm)	C (mm)	KG
	ML156A--0000	1205	370	8	9,0

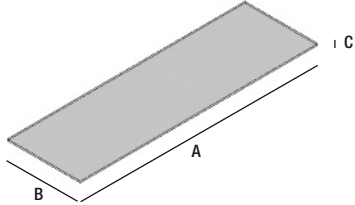

Ripiano basso in cristallo per tavolo.  
Lower crystal shelf for table.  
Niedriger Glasfachboden für Tisch.  
Étagère inférieure en cristal pour table.  
Нижняя стеклянная полка для стола.

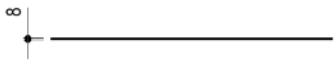

TYPE 157	COD.	KG
	ML157A--0000	0,11



Set (n°4 pezzi) di supporti per ripiani.  
Set (no. 4 pcs) of brackets for shelves.  
Trägersatz (4 Stück) für Fachböden.  
Kit (4 pièces) supports pour étagère.  
Набор (4 шт.) полкодержателей.



TYPE 158	COD.	A (mm)	KG
	ML158A--0000	Ø23	0,001

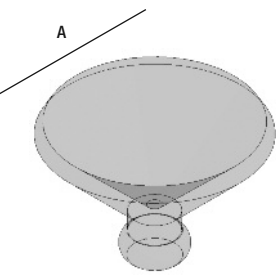

Ventosa per ripiani in cristallo.  
Suction caps for crystal shelves.  
Säuger für Glasböden.  
Ventouse pour étagère en cristal.  
Присоска для стеклянной полки.

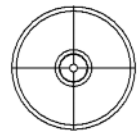

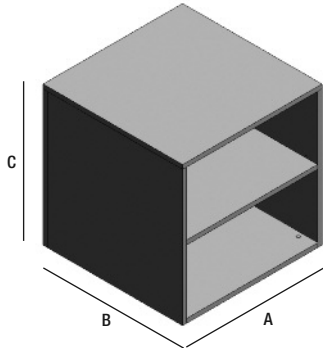
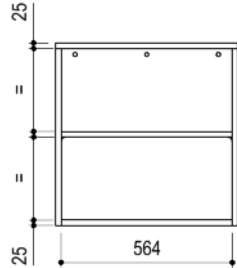

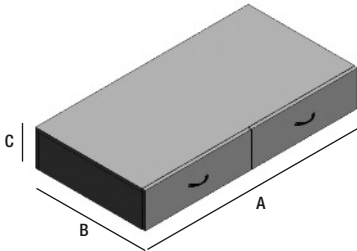
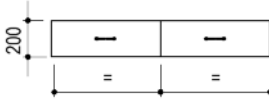

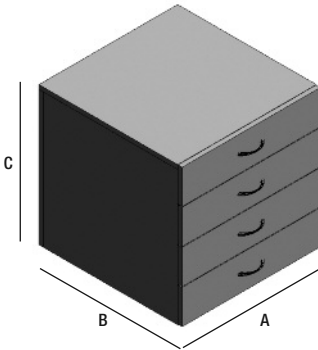
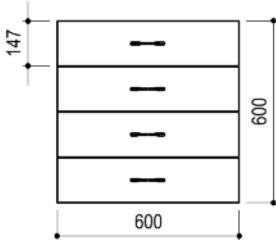
TYPE 159	COD.	A (mm)	B (mm)	C (mm)	KG
	ML159A--0000	600	600	600	26,9
	<p>Modulo con vani a giorno per telaio tavolo.                      Cabinet with open compartments for table frame.                      Theke mit offenen Fächern für Tischrahmen.                      Comptoir avec pièces à claire-voie pour chassis pour table.                      Модуль с открытыми нишами для каркаса стола.</p>				
					

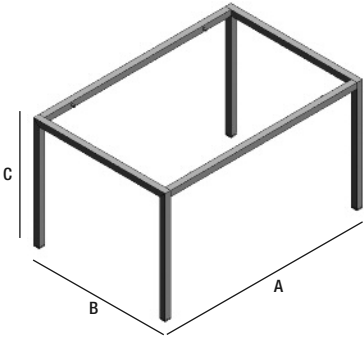
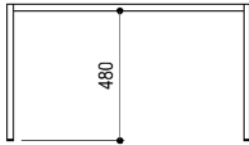
TYPE 160	COD.	A (mm)	B (mm)	C (mm)	KG
	ML160A--0000	1200	600	200	38,6
	<p>Modulo con cassetiera orizzontale a 2 cassetti per telaio tavolo.                      Horizontal 2-drawer unit for table frame.                      Waagerechte Theke mit 2 Schubladen für Tischrahmen.                      Comptoir avec meuble horizontal 2 tiroirs pour chassis pour table.                      Модуль с двумя горизонтальными ящиками для каркаса стола.</p>				
					

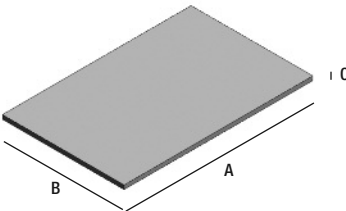

TYPE 161	COD.	A (mm)	B (mm)	C (mm)	KG
	ML161A--0000	600	600	600	43,6
	<p>Modulo con cassetiera a 4 cassetti per telaio tavolo.                      4-drawer unit for table frame.                      Theke mit 4 Schubladen für Tischrahmen.                      Comptoir avec meuble 4 tiroirs pour chassis pour table.                      Модуль из 4-х ящиков для каркаса стола.</p>				
					

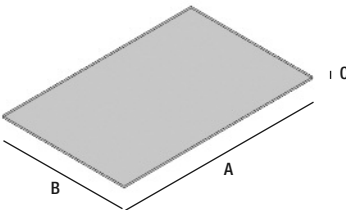

TYPE 162	COD.	A (mm)	B (mm)	C (mm)	KG
	<b>ML162A--0000</b>	900	600	500	5,2
<p>Telaio per tavolo. Table frame. Tischrahmen. Chassis pour table. Каркас стола.</p> 					

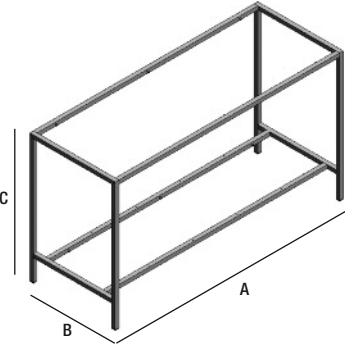
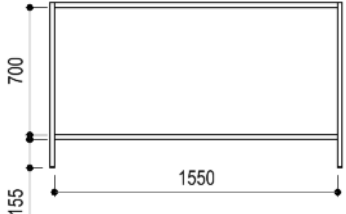
TYPE 163	COD.	A (mm)	B (mm)	C (mm)	KG
	<b>ML163A--0000</b>	845	545	18	5,58
<p>Ripiano top in legno per tavolo. Upper wooden shelf for table. Oberer Holzboden für Tisch. Étagère supérieure en bois pour table. Деревянная столешница.</p> 					

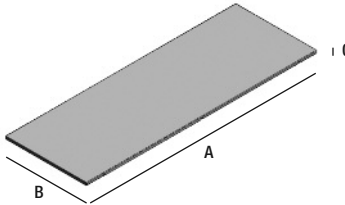
TYPE 164	COD.	A (mm)	B (mm)	C (mm)	KG
	<b>ML164A--0000</b>	845	545	8	7,8
<p>Ripiano top in cristallo per tavolo. Upper crystal shelf for table. Oberer Glasfachboden für Tisch. Étagère supérieure en cristal pour table. Стеклопанельная столешница.</p> 					

TYPE 165	COD.	A (mm)	B (mm)	C (mm)	KG
	ML165A--0000	1600	600	900	20,3
<p>Telaio per tavolo. Table frame. Tischrahmen. Chassis pour table. Каркас стола.</p>					

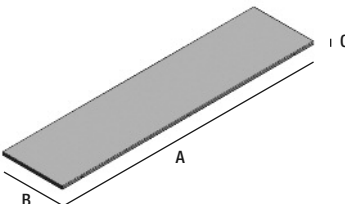
TYPE 166	COD.	A (mm)	B (mm)	C (mm)	KG
	ML166A--0000	1545	545	18	10,2
<p>Ripiano top in legno per tavolo. Upper wooden shelf for table. Oberer Holzboden für Tisch. Étagère supérieure en bois pour table. Деревянная столешница.</p>					

TYPE 167	COD.	A (mm)	B (mm)	C (mm)	KG
	ML167A--0000	1545	370	18	6,92
<p>Ripiano basso in legno per tavolo. Lower wooden shelf for table. Niedriger Holzboden für Tisch. Étagère inférieure en bois pour table. Нижняя деревянная полка для стола.</p>					

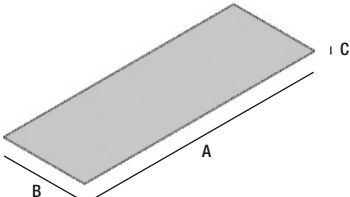
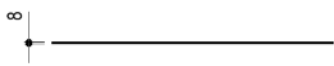
TYPE 168	COD.	A (mm)	B (mm)	C (mm)	KG
	<b>ML168A--0000</b>	1545	545	8	17,0
	<p>Ripiano top in cristallo per tavolo. Upper crystal shelf for table. Oberer Glasfachboden für Tisch. Étagère supérieure en cristal pour table. Стеклопанель столешница.</p>				
					

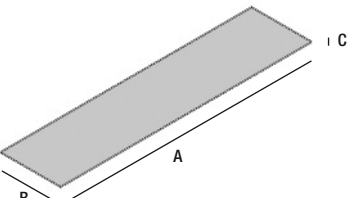
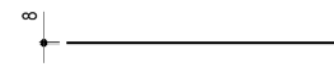
TYPE 169	COD.	A (mm)	B (mm)	C (mm)	KG
	<b>ML169A--0000</b>	1545	370	8	11,6
	<p>Ripiano basso in cristallo per tavolo. Lower crystal shelf for table. Niedriger Glasfachboden für Tisch. Étagère inférieure en cristal pour table. Нижняя стеклянная полка для стола.</p>				
					

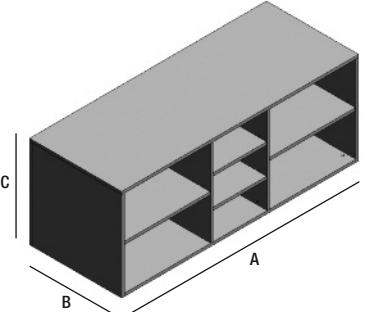
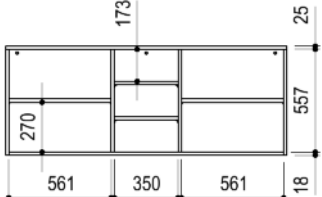
TYPE 170	COD.	A (mm)	B (mm)	C (mm)	KG
	<b>ML170A--0000</b>	1545	600	600	66,9
	<p>Modulo banco con vani a giorno per telaio tavolo. Cash register counter with open compartments for table frame. Ladentheke mit offenen Fächern für Tischrahmen. Comptoir avec pièces à claire-voie pour chassiss pour table. Модуль прилавка с открытыми нишами для стола.</p>				
					

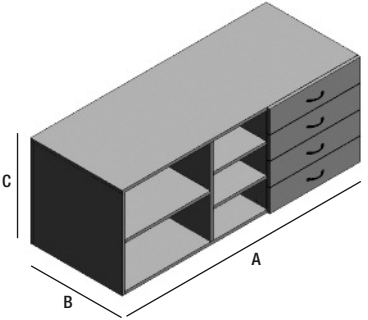
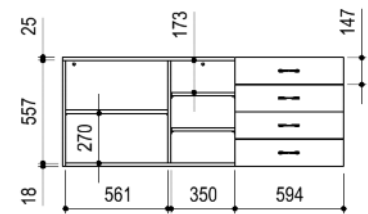
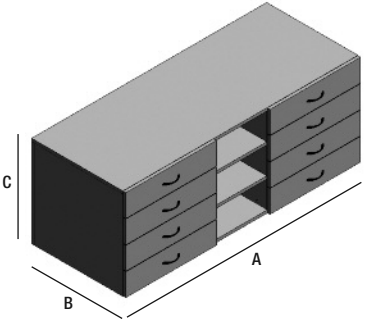
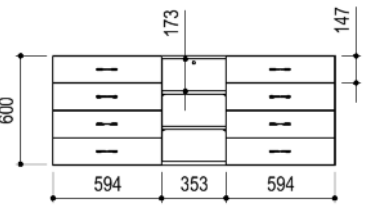
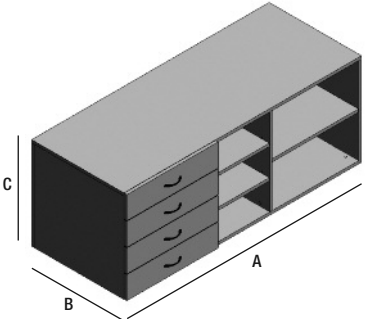
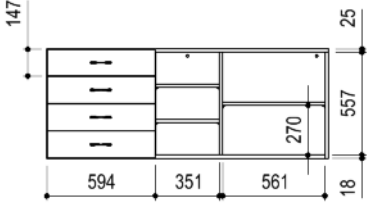
TYPE 171	COD.	A (mm)	B (mm)	C (mm)	KG		
	ML171A--0000	1545	620	600	83,6		 <p data-bbox="668 467 1311 565">                     Modulo banco con 4 cassetti dx e vani a giorno per telaio tavolo.                      Cash register counter with four drawers on the right and open compartments for table frame.                      Ladentheke mit vier Schubladen rechts und offenen Fächern für Tischrahmen.                      Comptoir avec 4 tiroirs droits et pièces à claire-voie.                      Модуль прилавка с 4-мя правыми ящиками.                 </p>
TYPE 172	COD.	A (mm)	B (mm)	C (mm)	KG		
	ML172A--0000	1545	620	600	100,2		 <p data-bbox="668 943 1292 1040">                     Modulo banco con 4 cassetti dx e 4 cassetti sx per telaio tavolo.                      Cash register counter with 4 drawers on the right and 4 drawers on the left for table frame.                      Ladentheke mit vier Schubladen rechts und vier Schubladen links für Tischrahmen.                      Comptoir avec 4 tiroirs droits et 4 tiroirs gauches pour chassiss pour table.                      Модуль прилавка с 4-мя правыми и 4-мя левыми ящиками для стола.                 </p>
TYPE 173	COD.	A (mm)	B (mm)	C (mm)	KG		
	ML173A--0000	1545	620	600	83,6		 <p data-bbox="668 1414 1292 1511">                     Modulo banco con 4 cassetti sx e vani a giorno per telaio tavolo.                      Cash register counter with 4 drawers on the left and open compartments for table frame.                      Ladentheke mit vier Schubladen links und offenen Fächern für Tischrahmen.                      Comptoir avec 4 tiroirs gauches et pièces pour chassiss pour table.                      Модуль прилавка с 4-мя левыми ящиками и открытыми полками для стола.                 </p>

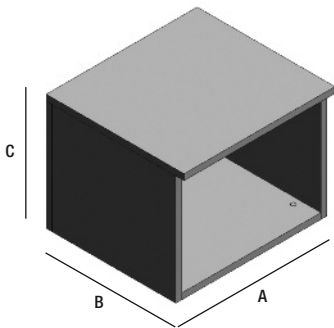
TYPE 200	COD.	A (mm)	B (mm)	C (mm)	KG
	<b>ML200A--0000</b>	460	420	354	10,4
	<p>Mobile con vano a giorno.                      Cabinet with one open compartment.                      Theke mit offenem Fach.                      Comptoir avec pièce à claire-voie.                      Открытый модуль.</p>				

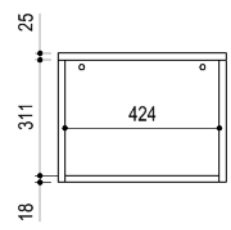

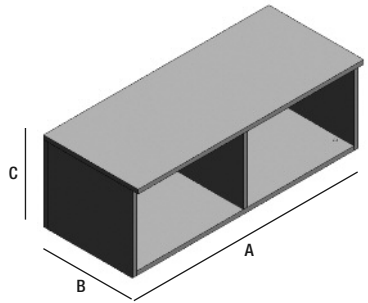
TYPE 201	COD.	A (mm)	B (mm)	C (mm)	KG
	<b>ML201A--0000</b>	1000	420	354	20,6
	<b>ML201B--0000</b>	1200	420	354	23,7
<p>Mobile con 2 vani a giorno.                      Cabinet with two open compartments.                      Theke mit zwei offenen Fächern.                      Comptoir avec 2 pièces à claire-voie.                      Двойной открытый модуль.</p>					

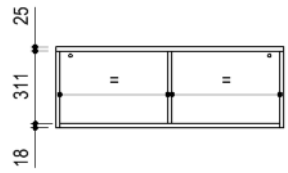

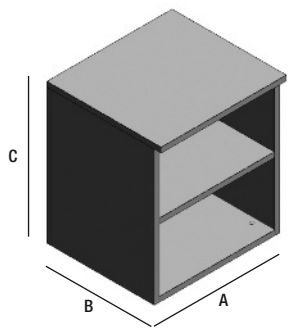
TYPE 202	COD.	A (mm)	B (mm)	C (mm)	KG
	<b>ML202A--0000</b>	460	420	514	14,7
	<p>Mobile con 1 ripiano spostabile.                      Cabinet with one adjustable shelf.                      Theke mit einem höhenverstellbaren Boden.                      Comptoir avec un étagère réglable.                      Модуль с одной перемещаемой полкой.</p>				

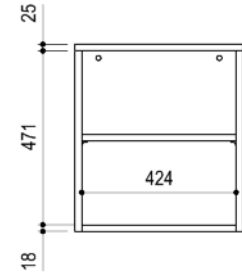

**TYPE 203**

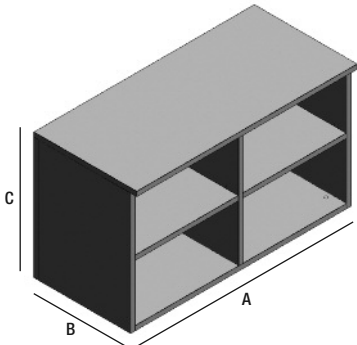

COD.	A (mm)	B (mm)	C (mm)	KG
ML203A--0000	900	420	514	26,7
ML203B--0000	1000	420	514	29,0
ML203C--0000	1200	420	514	33,5

Moblie con 4 vani a giorno.  
Cabinet with four open compartments.  
Theke mit vier offenen Fächern.  
Comptoir avec 4 pièces à claire-voie.  
Открытый модуль с 4-мя полками.

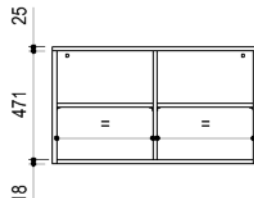

**TYPE 204**

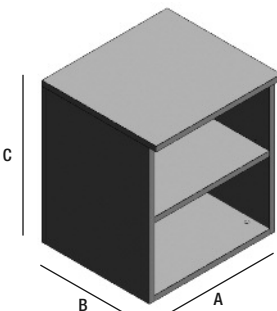

COD.	A (mm)	B (mm)	C (mm)	KG
ML204A--0000	460	420	674	17,0

Moblie con 1 ripiano spostabile.  
Cabinet with one adjustable shelf.  
Theke mit einem höhenverstellbaren Boden.  
Comptoir avec un étagère réglable.  
Открытый модуль с перемещаемой полкой.

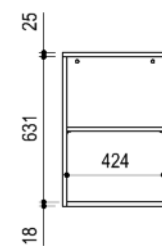

**TYPE 205**

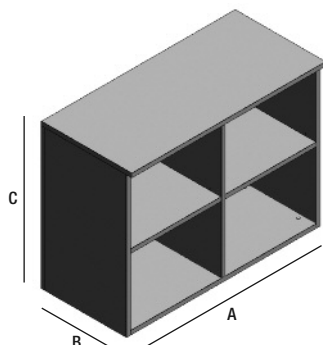

COD.	A (mm)	B (mm)	C (mm)	KG
ML205A--0000	900	420	674	30,6
ML205B--0000	1000	420	674	33,2
ML205C--0000	1200	420	674	38,0

Moblie con 4 vani a giorno.  
Cabinet with four open compartments.  
Theke mit vier offenen Fächern.  
Comptoir avec 4 pièces à claire-voie.  
Открытый модуль с 4-мя полками.

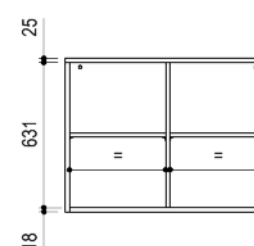

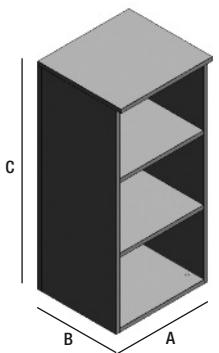
TYPE 206	COD.	A (mm)	B (mm)	C (mm)	KG
	<b>ML206A--0000</b>	460	420	994	23,6
	<p>Mobile con 2 ripiani spostabili.                      Cabinet with two adjustable shelves.                      Theke mit zwei höhenverstellbaren Fachböden.                      Comptoir avec 2 étagères réglables.                      Модуль с двумя перемещаемыми полками.</p>				

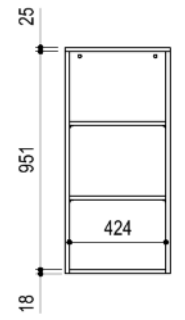

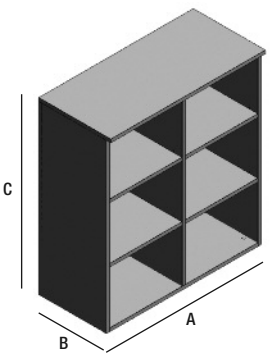
TYPE 207	COD.	A (mm)	B (mm)	C (mm)	KG
	<b>ML207A--0000</b>	900	420	994	43,3
	<p>Mobile con 6 vani a giorno.                      Cabinet with six open compartments.                      Theke mit sechs offenen Fächern.                      Comptoir avec 6 pièces à claire-voie.                      Открытый модуль с шестью открытыми нишами.</p>				

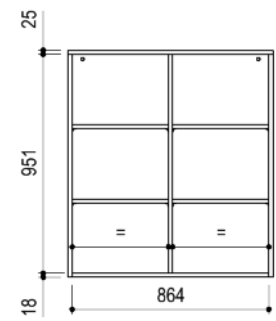

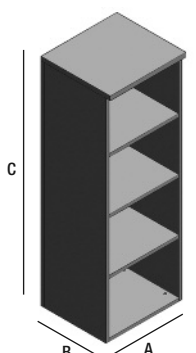
TYPE 208	COD.	A (mm)	B (mm)	C (mm)	KG
	<b>ML208A--0000</b>	460	420	1314	30,3
	<b>ML208B--0000</b>	610	420	1314	36,3
<p>Mobile con 4 vani a giorno.                      Cabinet with four open compartments.                      Theke mit vier offenen Fächern.                      Comptoir avec 4 pièces à claire-voie.                      Модуль с 4-мя открытыми нишами.</p>					

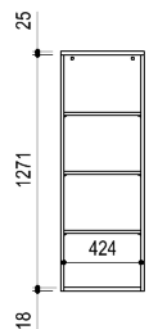

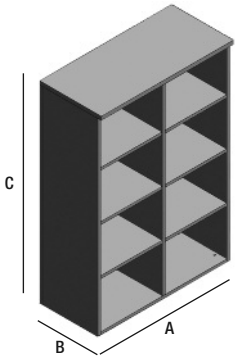
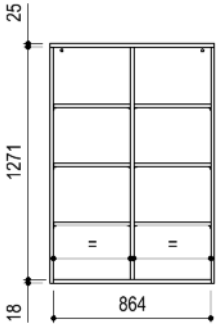
TYPE 209	COD.	A (mm)	B (mm)	C (mm)	KG
	ML209A--0000	900	420	1314	54,0
	<p>Mobile con 8 vani a giorno.                      Cabinet with eight open compartments.                      Theke mit acht offenen Fächern.                      Comptoir avec 8 pièces à claire-voie.                      Модуль с 8-ю открытыми нишами.</p>				
					

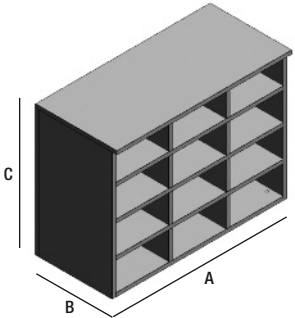
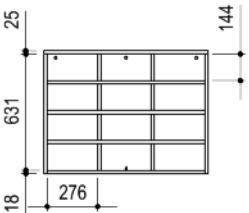
TYPE 210	COD.	A (mm)	B (mm)	C (mm)	KG
	ML210A--0000	900	420	674	41,2
	<p>Mobile casellario.                      Filing cabinet.                      Aktenschrank.                      Comptoir avec 12 tiroirs.                      Шкафчик картотека.</p>				
					

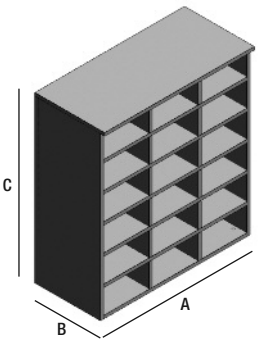
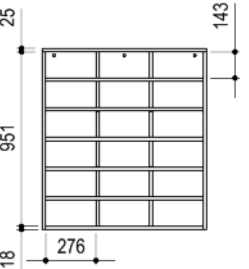
TYPE 211	COD.	A (mm)	B (mm)	C (mm)	KG
	ML211A--0000	900	420	994	58,9
	<p>Mobile casellario.                      Filing cabinet.                      Aktenschrank.                      Comptoir avec 18 tiroirs.                      Шкафчик картотек.</p>				
					

**TYPE 250**

COD.	A (mm)	B (mm)	C (mm)	KG
ML250A--0000	610	420	514	19,0

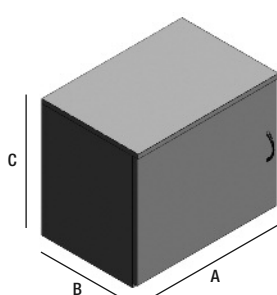

Moblie con anta sx.  
Cabinet with a door on the left.  
Theke mit einer Tür links.  
Comptoir avec porte gauche.  
Модуль с левой створкой.

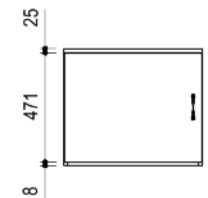

**TYPE 251**

COD.	A (mm)	B (mm)	C (mm)	KG
ML251A--0000	900	420	514	28,3
ML251B--0000	1000	420	514	30,7
ML251C--0000	1200	420	514	35,4

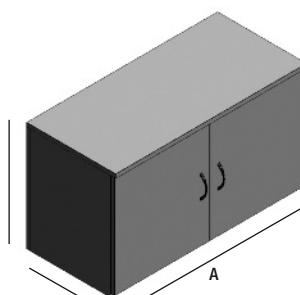

Moblie con 2 ante.  
Cabinet with two doors.  
Theke mit zwei Türen.  
Comptoir avec 2 portes.  
Модуль с двумя створками.

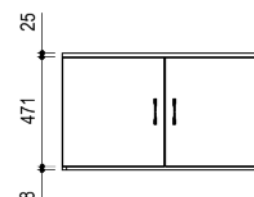

**TYPE 252**

COD.	A (mm)	B (mm)	C (mm)	KG
ML252A--0000	460	420	674	20,7
ML252B--0000	610	420	674	25,5

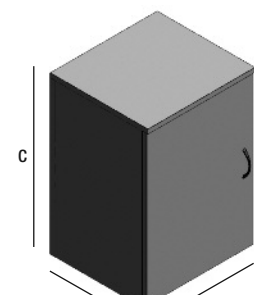

Moblie con anta sx e 1 ripiano interno.  
Cabinet with a door on the left and one shelf inside.  
Theke mit einer Tür links und einem inneren Boden.  
Comptoir avec porte gauche et étagère à l'intérieur.  
Модуль с левой створкой и одной внутренней полкой.

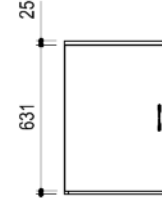

**TYPE 253**

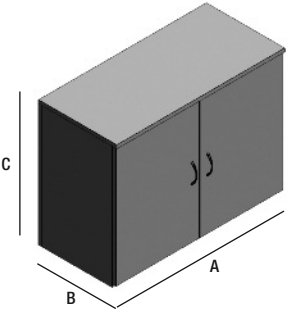

COD.	A (mm)	B (mm)	C (mm)	KG
ML253A--0000	900	420	674	37,8
ML253B--0000	1000	420	674	41,1
ML253C--0000	1200	420	674	47,5

Moblie con 2 ante e 1 ripiano interno.  
 Cabinet with two doors and one shelf inside.  
 Theke mit zwei Türen und einem inneren Boden.  
 Comptoir avec 2 portes et étagère à l'intérieur.  
 Модуль с двумя створками и внутренней полкой.

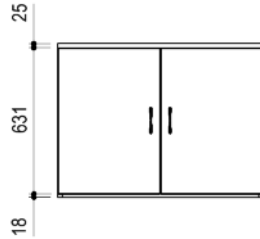

**TYPE 254**

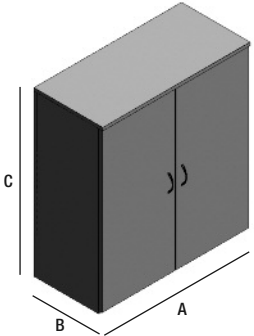

COD.	A (mm)	B (mm)	C (mm)	KG
ML254A--0000	900	420	994	52,9

Moblie con 2 ante e 2 ripiani interni.  
 Cabinet with two doors and two shelves inside.  
 Theke mit zwei Türen und zwei inneren Böden.  
 Comptoir avec 2 portes et 2 étagères à l'intérieur.  
 Модуль с двумя створками и двумя внутренними полками.

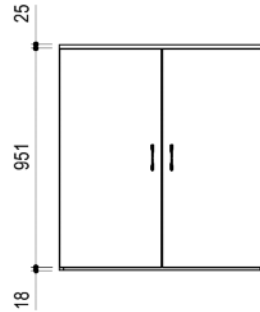

**TYPE 300**

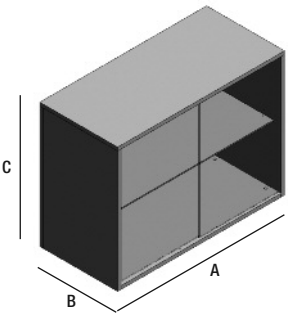

COD.	A (mm)	B (mm)	C (mm)	KG
ML300A----00	900	420	674	37,8
ML300B----00	1000	420	674	41,5
ML300C----00	1200	420	674	48,2

Moblie con 2 ante scorrevoli in vetro e 1 ripiano interno.  
 Showcase with two sliding glass doors and one shelf inside.  
 Thekenvitrine mit zwei Glas-Schiebetüren und einem inneren Boden.  
 Comptoir avec 2 portes coulissantes en verre et 1 étagère à l'intérieur.  
 Модуль с двумя раздвижными стеклянными створками и внутренней полкой.

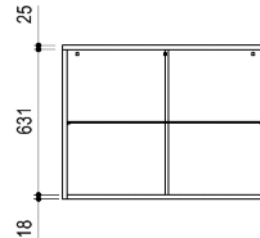

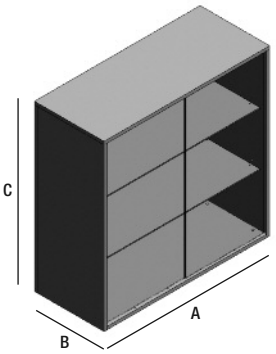
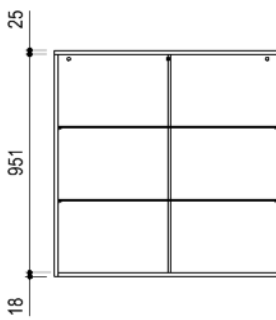
TYPE 301	COD.	A (mm)	B (mm)	C (mm)	KG
	ML301A----00	1000	420	994	53,2
<p>Mobile con 2 ante scorrevoli in vetro e 2 ripiani interni.                      Showcase with two sliding glass doors and two shelves inside.                      Thekenvitrine mit zwei Glas-Schiebetüren und zwei inneren Böden.                      Comptoir avec 2 portes coulissantes en verre et 1 étagère à l'intérieur.                      Модуль с двумя раздвижными стеклянными створками и двумя полками.</p>					
					

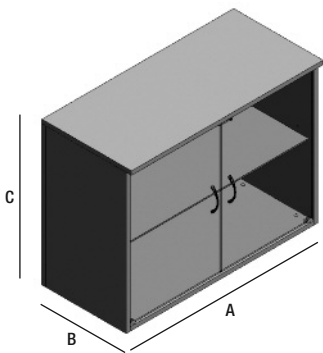
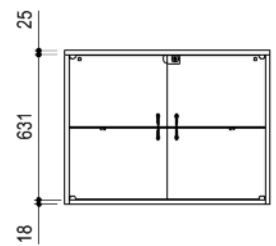
TYPE 350	COD.	A (mm)	B (mm)	C (mm)	KG
	ML350A----00	900	420	674	36,8
<p>Mobile con 2 ante a battente in vetro e 1 ripiano interno.                      Showcase with two glass doors and one shelf inside.                      Thekenvitrine mit zwei Glas-Schwenktüren und einem inneren Boden.                      Comptoir avec 2 portes en verre et 1 étagère à l'intérieur.                      Модуль с двумя стеклянными створками и одной полкой.</p>					
					

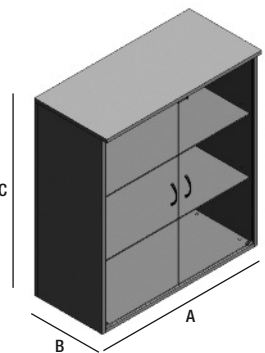
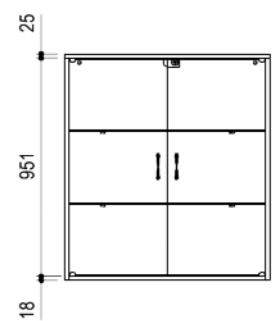
TYPE 351	COD.	A (mm)	B (mm)	C (mm)	KG
	ML351A----00	900	420	994	47,3
<p>Mobile con 2 ante a battente in vetro e 2 ripiani interni.                      Showcase with two glass doors and two shelves inside.                      Thekenvitrine mit zwei Glas-Schwenktüren und zwei inneren Böden.                      Comptoir avec 2 portes en verre et 2 étagères à l'intérieur.                      Модуль с двумя стеклянными створками и двумя полками.</p>					
					

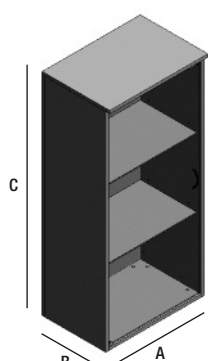
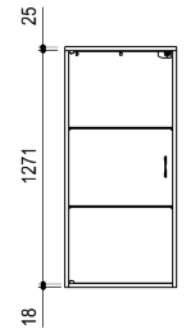
TYPE 352	COD.	A (mm)	B (mm)	C (mm)	KG
	ML352A----00	610	420	1314	48,9
	<p>Mobile con 1 anta a battente in vetro e 2 ripiani interni.                      Showcase with a glass door and two shelves inside.                      Thekenvitrine mit einer Glas-Schwenktür und zwei inneren Böden.                      Comptoir avec une porte en verre et 2 étagères à l'intérieur.                      Модуль со стеклянной створкой и двумя полками.</p>				
					

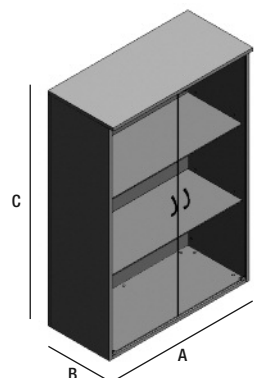
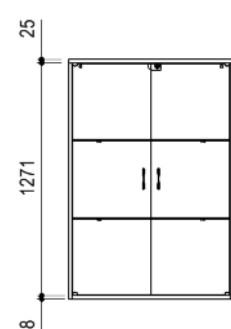
TYPE 353	COD.	A (mm)	B (mm)	C (mm)	KG
	ML353A----00	900	420	1314	62,4
	<p>Mobile con 2 ante a battente in vetro e 2 ripiani interni.                      Showcase with two glass doors and two shelves inside.                      Thekenvitrine mit zwei Glas-Schwenktüren und zwei inneren Böden.                      Comptoir avec 2 portes en verre et 2 étagères à l'intérieur.                      Модуль с двумя стеклянными створками и двумя полками.</p>				
					

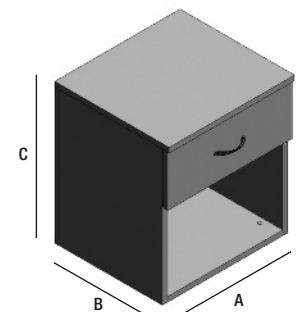
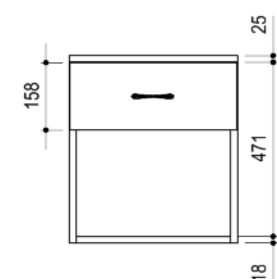
TYPE 400	COD.	A (mm)	B (mm)	C (mm)	KG
	ML400A--0000	460	420	514	16,1
	<p>Mobile con cassetto e vano a giorno.                      Cabinet with a drawer and an open compartment.                      Theke mit Schublade und offenem Fach.                      Comptoir avec tiroir et pièce à claire-voie.                      Модуль с выдвижным ящиком и открытой нишей.</p>				
					

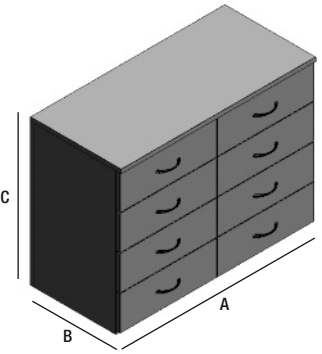
TYPE 401	COD.	A (mm)	B (mm)	C (mm)	KG
	<b>ML401A--0000</b>	900	420	674	53,4

Mobile con 8 cassetti.  
Cabinet with eight drawers.  
Theke mit acht Schubladen.  
Comptoir avec 8 tiroirs.  
Модуль с 8-ю выдвижными ящиками.

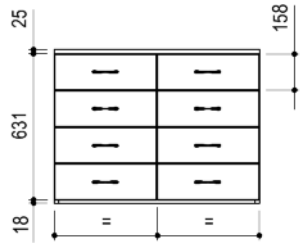

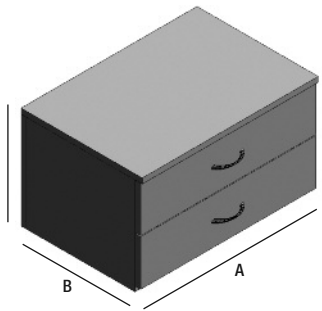
TYPE 402	COD.	A (mm)	B (mm)	C (mm)	KG
	<b>ML402A--0000</b>	610	420	354	21,1

Mobile con 2 cassetti.  
Cabinet with two drawers.  
Theke mit zwei Schubladen.  
Comptoir avec 2 tiroirs.  
Модуль с двумя ящиками.

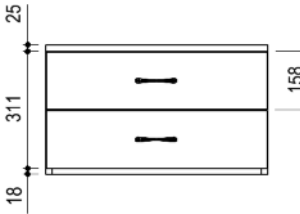

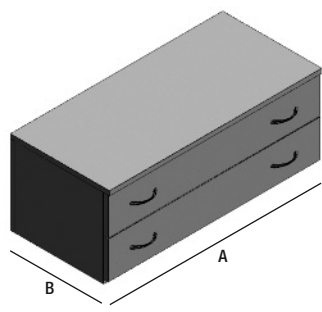
TYPE 403	COD.	A (mm)	B (mm)	C (mm)	KG
	<b>ML403A--0000</b>	900	420	354	29,0
	<b>ML403B--0000</b>	1000	420	354	31,8
	<b>ML403C--0000</b>	1200	420	354	37,2

Mobile con 2 cassetti.  
Cabinet with two drawers.  
Theke mit zwei Schubladen.  
Comptoir avec 2 tiroirs.  
Модуль с двумя ящиками.

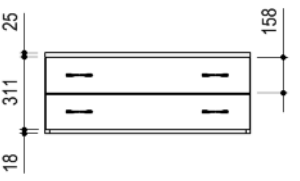

**TYPE 404**

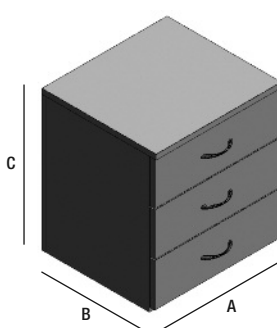

COD.	A (mm)	B (mm)	C (mm)	KG
ML404A--0000	460	420	514	22,8
ML404B--0000	610	420	514	27,9

Mobile con 3 cassetti.  
Cabinet with three drawers.  
Theke mit drei Schubladen.  
Comptoir avec 3 tiroirs.  
Модуль с тремя ящиками.

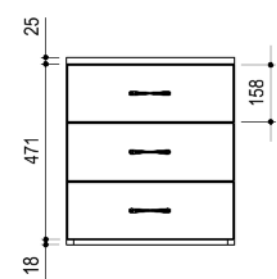

**TYPE 405**

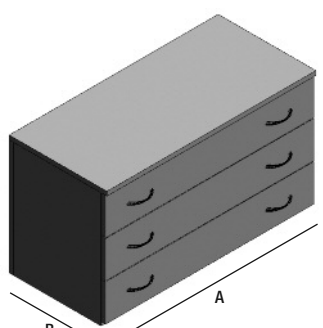

COD.	A (mm)	B (mm)	C (mm)	KG
ML405A--0000	900	420	514	38,0
ML405B--0000	1000	420	514	41,5
ML405C--0000	1200	420	514	48,3

Mobile con 3 cassetti.  
Cabinet with three drawers.  
Theke mit drei Schubladen.  
Comptoir avec 3 tiroirs.  
Модуль с тремя ящиками.

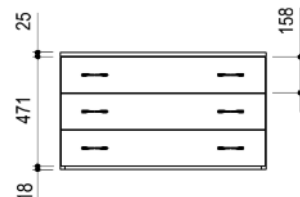

**TYPE 406**

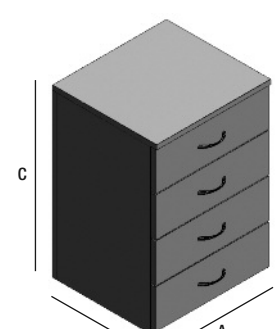

COD.	A (mm)	B (mm)	C (mm)	KG
ML406A--0000	460	420	674	28,5
ML406B--0000	610	420	674	34,7

Mobile con 4 cassetti.  
Cabinet with four drawers.  
Theke mit vier Schubladen.  
Comptoir avec 4 tiroirs.  
Модуль с 4-мя ящиками.

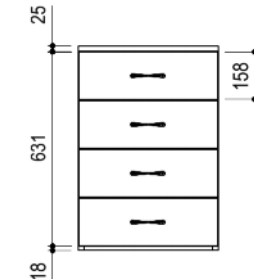

**TYPE 407**

COD.	A (mm)	B (mm)	C (mm)	KG
ML407A--0000	900	420	674	46,9
ML407B--0000	1000	420	674	51,2
ML407C--0000	1200	420	674	59,6

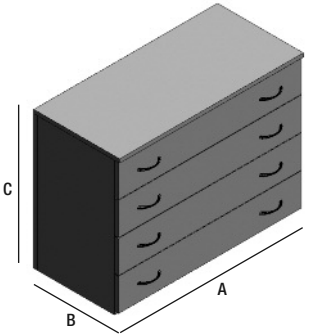

Moblie con 4 cassetti.  
Cabinet with four drawers.  
Theke mit vier Schubladen.  
Comptoir avec 4 tiroirs.  
Модуль с 4-мя ящиками.

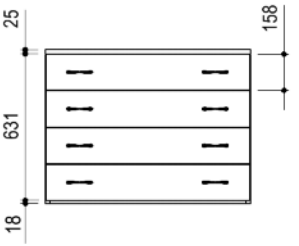

**TYPE 450**

COD.	A (mm)	B (mm)	C (mm)	KG
ML450A--0000	1200	420	514	47,0

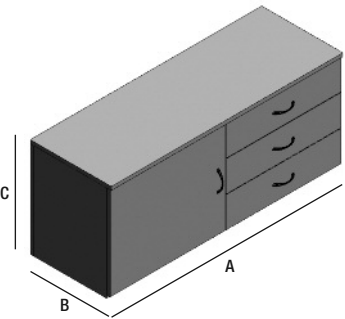

Moblie con anta sx e 3 cassetti a dx.  
Cabinet with a door on the left and three drawers on the right.  
Theke mit einer Schwenktür links und drei Schubladen rechts.  
Comptoir avec porte gauche et 3 tiroirs droits.  
Модуль с левой створкой и тремя выдвижными ящиками справа.

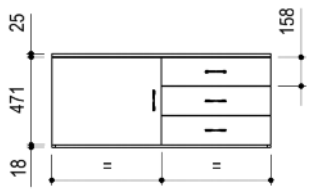

**TYPE 451**

COD.	A (mm)	B (mm)	C (mm)	KG
ML451A--0000	900	420	674	45,5

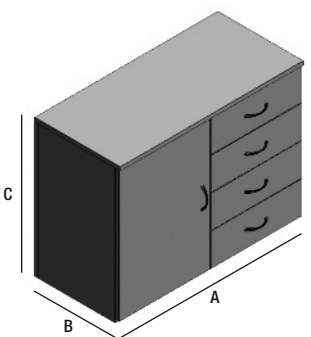

Moblie con anta sx e 4 cassetti a dx.  
Cabinet with a door on the left and four drawers on the right.  
Theke mit einer Schwenktür links und vier Schubladen rechts.  
Comptoir avec porte gauche et 4 tiroirs droits.  
Модуль с левой створкой и 4-мя выдвижными ящиками справа.

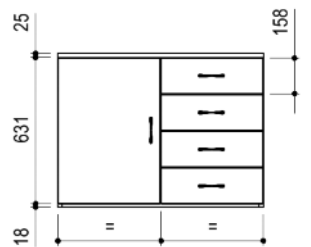

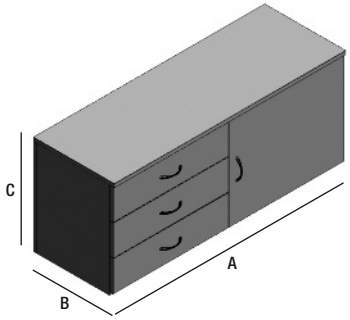
TYPE 452	COD.	A (mm)	B (mm)	C (mm)	KG
	<b>ML452A--0000</b>	1200	420	514	47,0

Mobile con anta dx e 3 cassetti a sx.  
 Cabinet with a door on the right and three drawers on the left.  
 Theke mit einer Schwenktür rechts und drei Schubladen links.  
 Comptoir avec porte droite et 3 tiroirs gauches.  
 Модуль с правой створкой и тремя выдвижными ящиками слева.

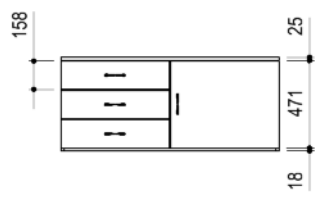

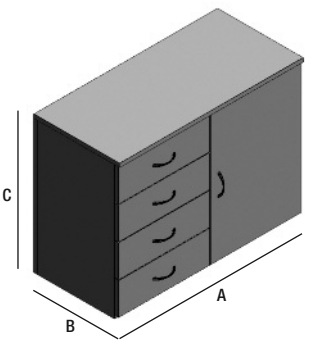
TYPE 453	COD.	A (mm)	B (mm)	C (mm)	KG
	<b>ML453A--0000</b>	900	420	674	45,5

Mobile con anta dx e 4 cassetti a sx.  
 Cabinet with a door on the right and four drawers on the left.  
 Theke mit einer Schwenktür rechts und vier Schubladen links.  
 Comptoir avec porte droite et 4 tiroirs gauches.  
 Модуль с правой створкой и 4-мя выдвижными ящиками слева.

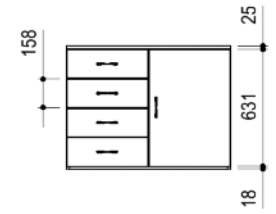

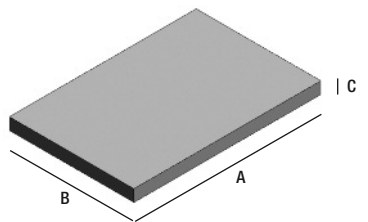
TYPE 900	COD.	A (mm)	B (mm)	C (mm)	KG
	<b>ML900A--0000</b>	600	400	38	3,38
	<b>ML900B--0000</b>	900	400	38	5,076
	<b>ML900C--0000</b>	1000	400	38	5,64
	<b>ML900D--0000</b>	1200	400	38	6,768

Ripiano tamburato.  
 Hollow-core shelf.  
 Furnierter Boden.  
 Etagère à âme alvéolaire.  
 Полка тамбурато.

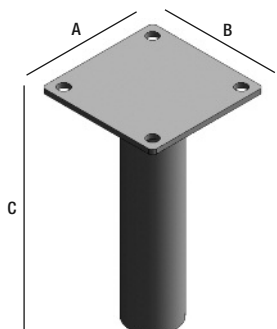
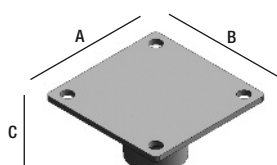
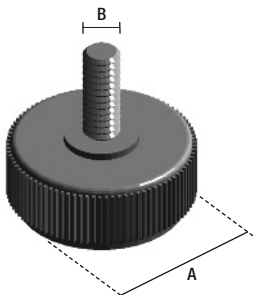

TYPE 950	COD.	A (mm)	B (mm)	C (mm)	KG
	<b>ML950A--0000</b>	60	60	107,5	0,21
	<p>Piastra per fissaggio piedino M10.                      Plate for M10 foot clamping.                      Platte zur Befestigung des Fusses M10.                      Plaque de fixation pour pied M10.                      Регулируемая опора для ножки M10.</p>				
TYPE 951	COD.	A (mm)	B (mm)	C (mm)	KG
	<b>ML951A--0000</b>	60	60	28	0,19
	<p>Piastra per fissaggio ruota.                      Plate for caster clamping.                      Radbefestigungsplatte.                      Plaque de fixation pour roulette.                      Опора для фиксации колесика.</p>				
TYPE 952	COD.	A (mm)	B (mm)	KG	
	<b>ML952A--0000</b>	Ø50	M10	0,058	
	<p>Piedino regolabile Ø50.                      Ø50 adjustable foot.                      Ø50 verstellbarer Fuss.                      Pied réglable Ø50.                      Регулируемая ножка Ø50.</p>				

TYPE 953	COD.	A (mm)	B (mm)			KG
	ML953A--0000	Ø80	M10			0,325
<p>Ruota. Caster. Rad. Roulette. Колесо.</p>						

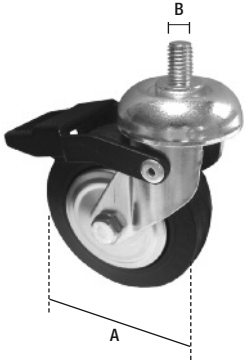
TYPE 954	COD.	A (mm)	B (mm)			KG
	ML954A--0000	Ø80	M10			0,34
<p>Ruota frenata. Caster with brake. Rad mit Bremse. Roulette avec freins. Колесная опора с тормозом.</p>						

MOBILI CON ANTE E CASSETTI CABINETS WITH DOORS AND DRAWERS

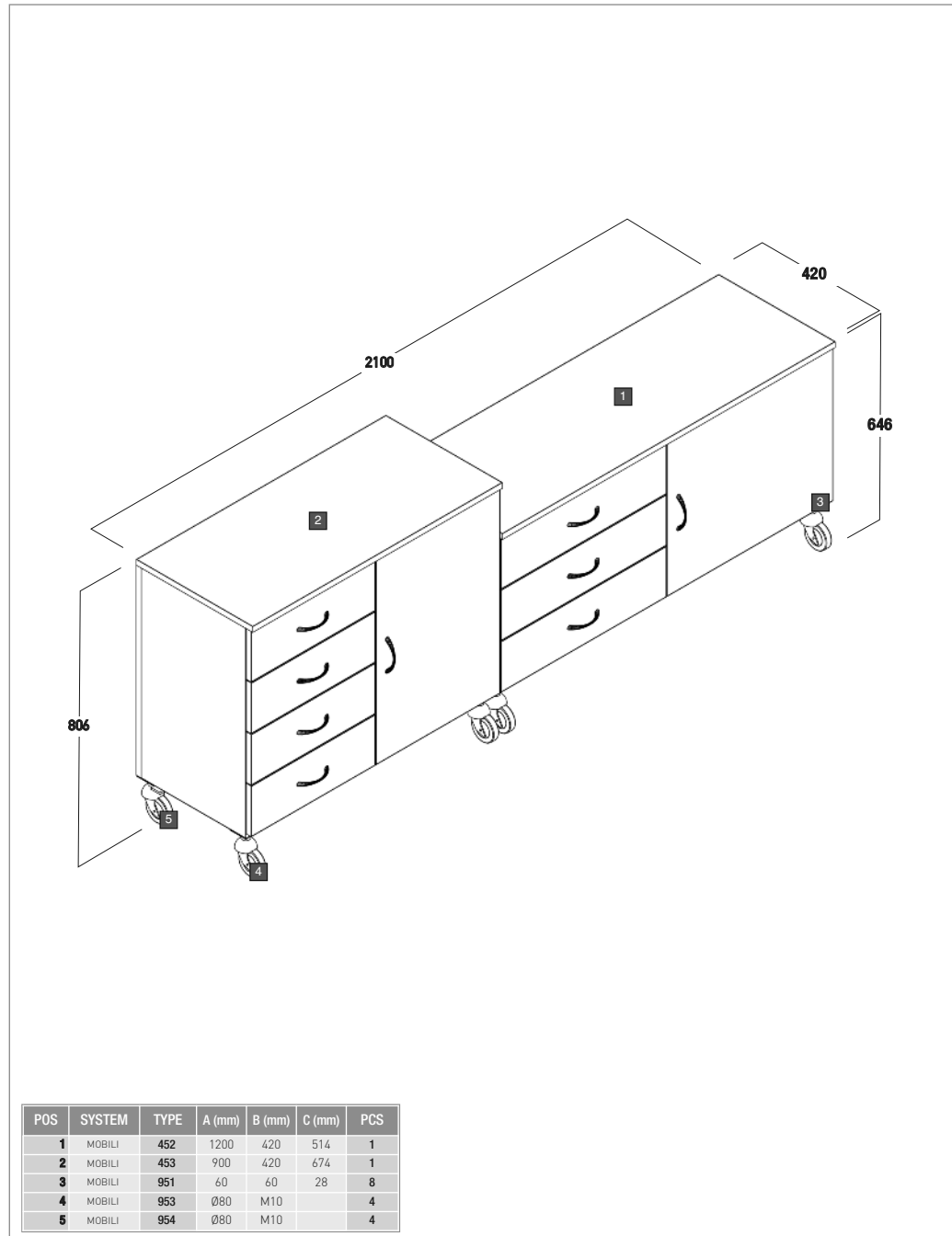

MOBILI CON ANTE SCORREVOLI IN VETRO CABINETS WITH SLIDING GLASS DOORS

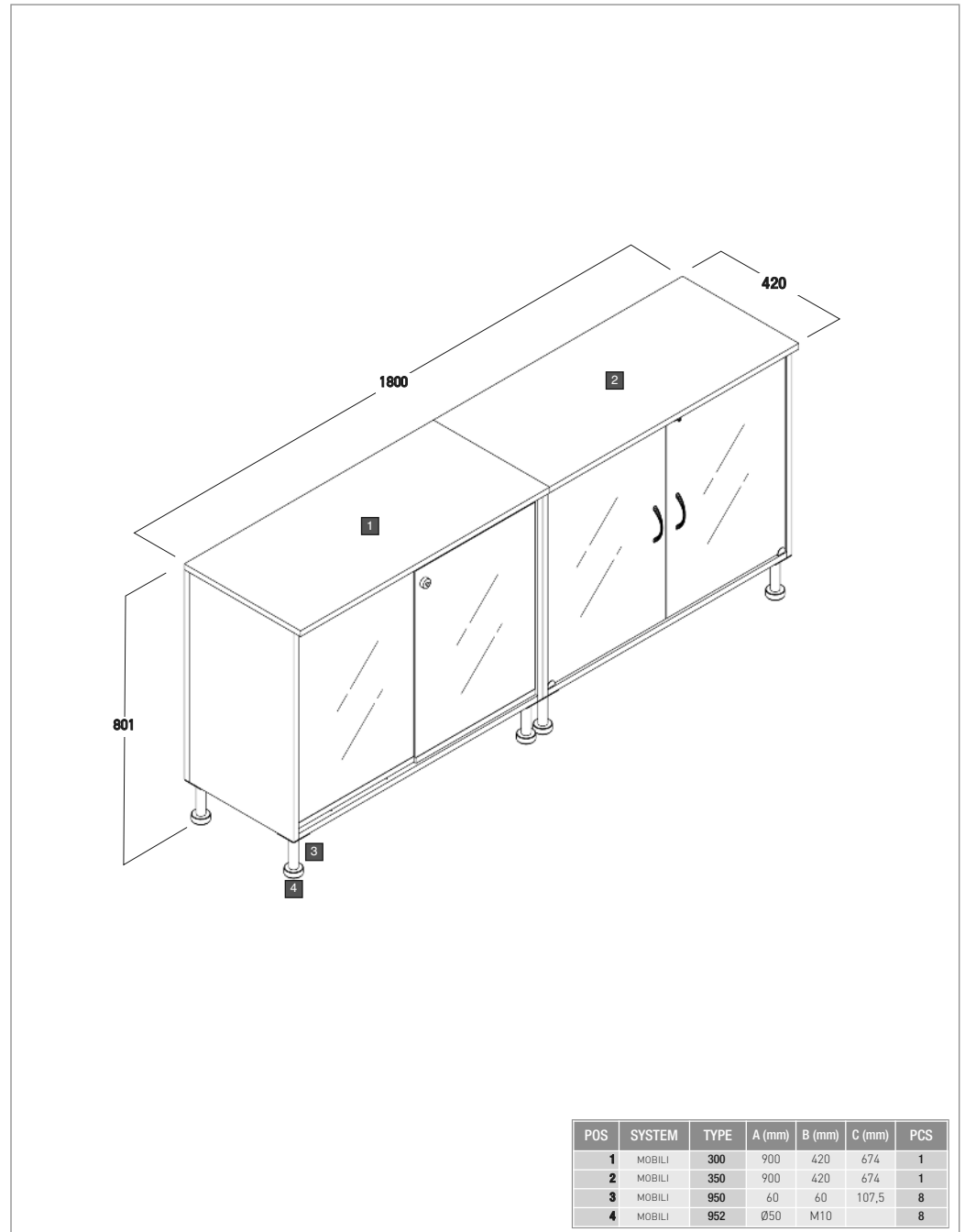

MOBILI VANI A GIORNO CABINETS WITH OPEN COMPARTMENTS

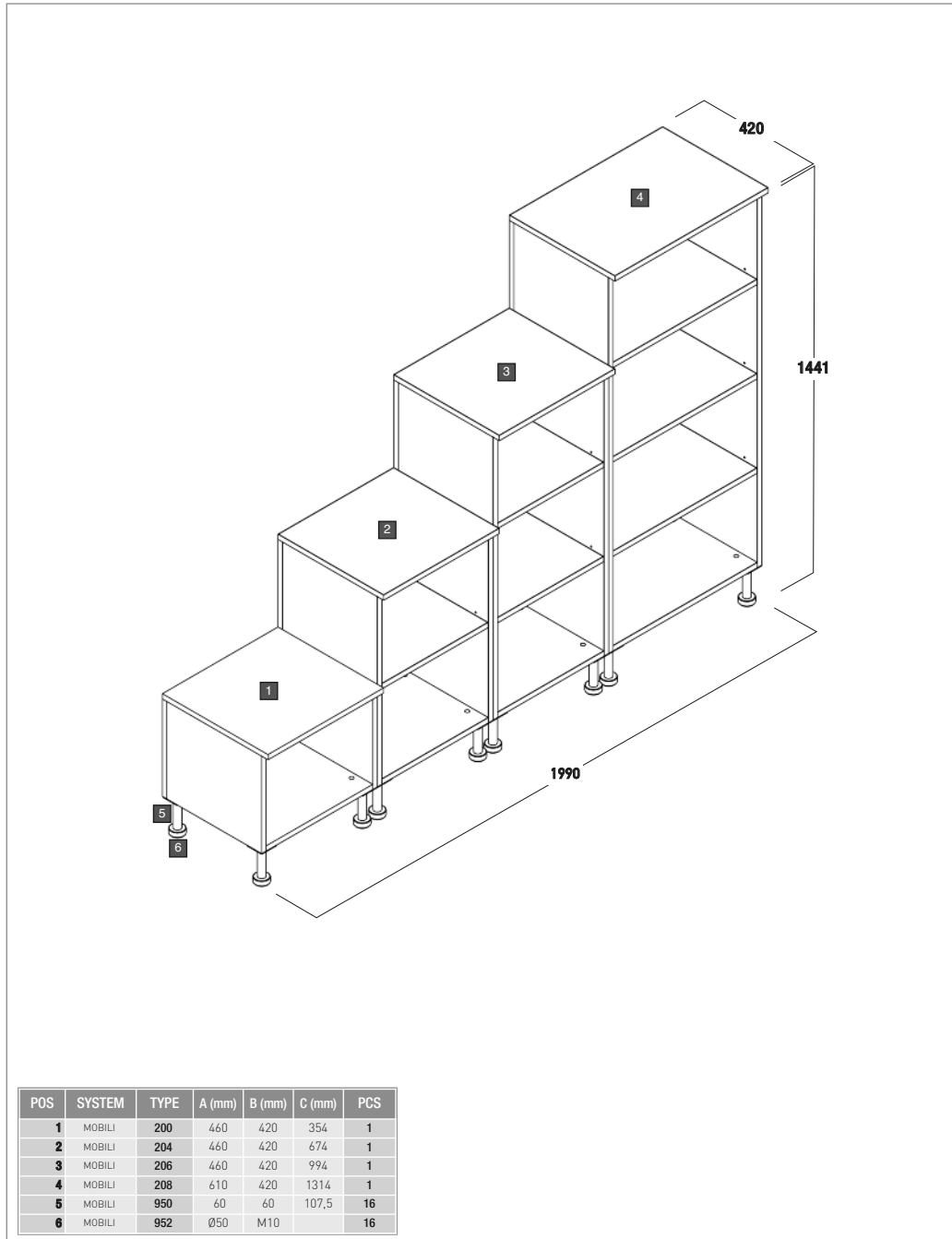

TAVOLO TABLE

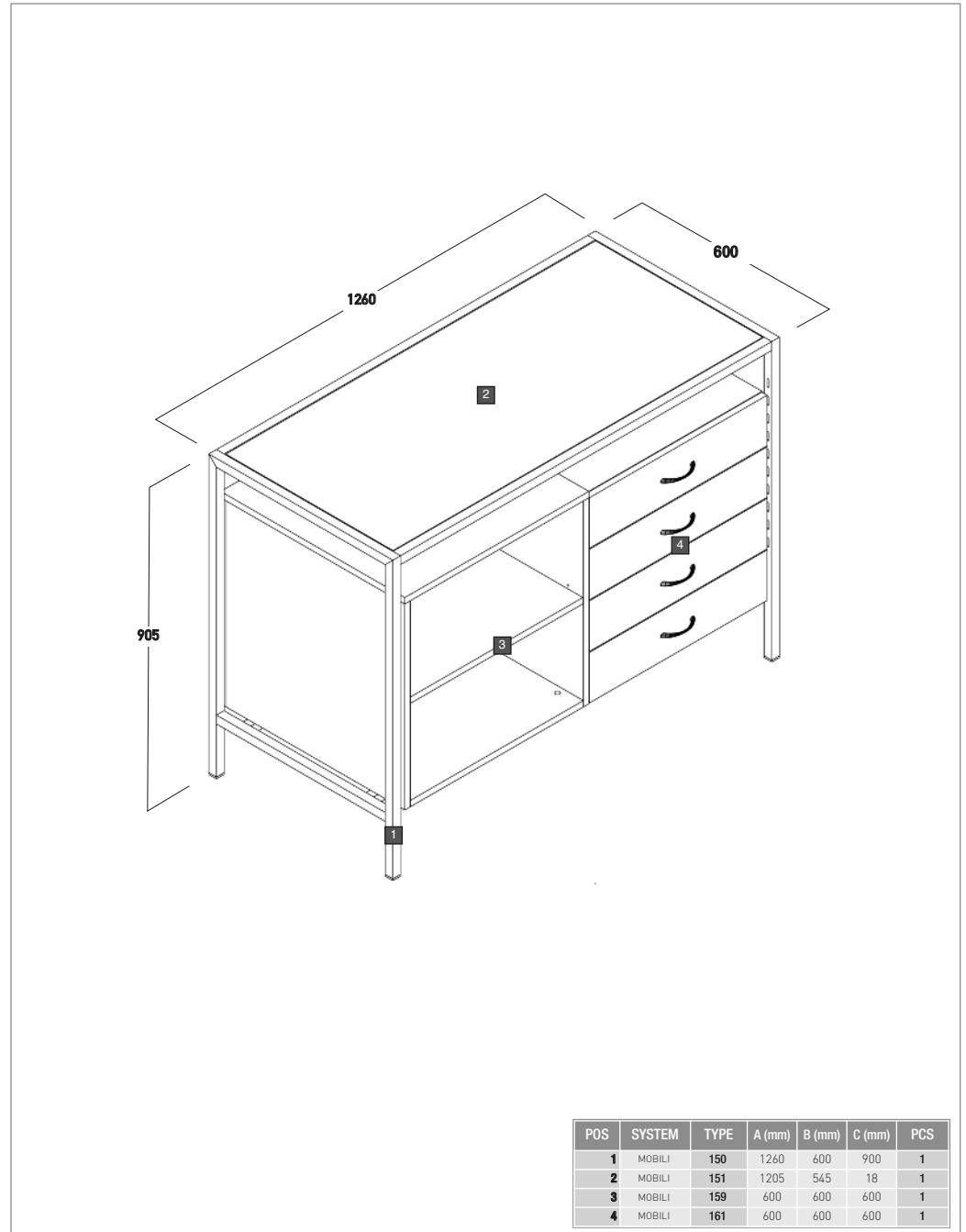

MOBILI ALTI TALL CABINETS

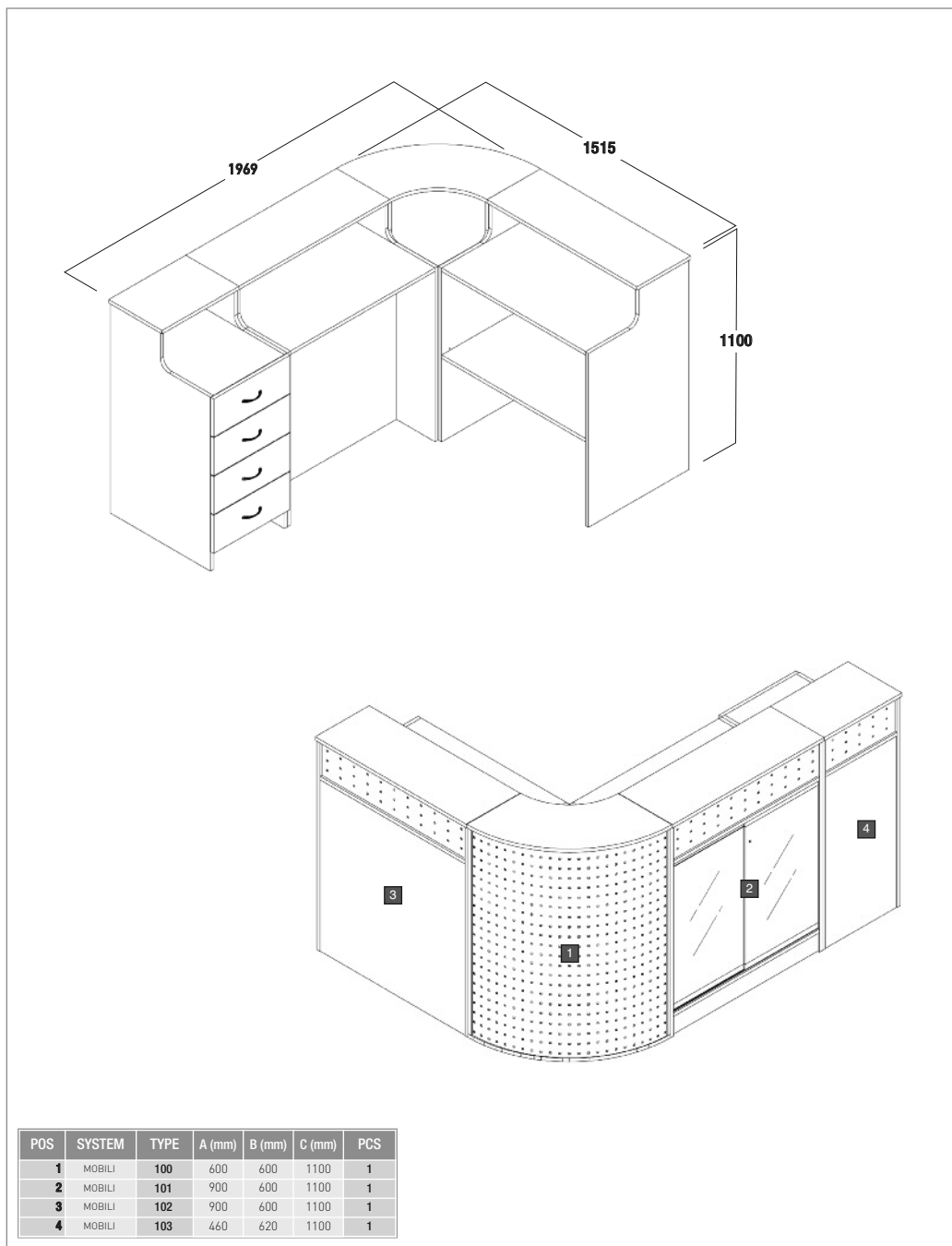

MOBILI DI SERVIZIO UTILITY CABINETS

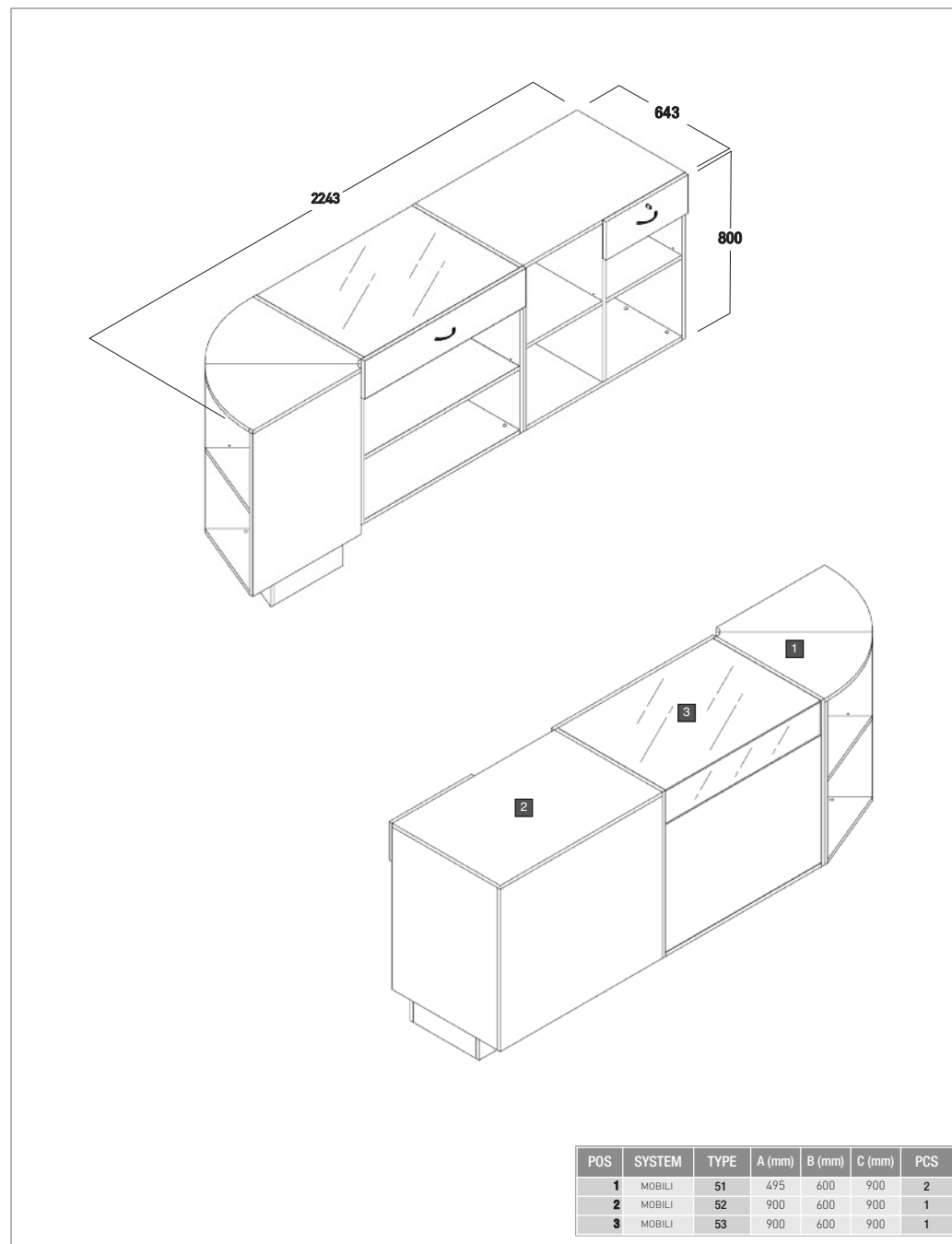

**NOTE:** GLI ARTICOLI SONO RAPPRESENTATI IN FORMA ASSEMBLATA SOLO PER UNA MIGLIORE COMPRESIONE DEL PRODOTTO.

SI FA NOTARE CHE, SALVO SPECIFICHE RICHIESTE DI MONTAGGIO DA PARTE DEL CLIENTE, PER CIASCUN ARTICOLO ORDINATO VERRANNO CONSEGNAI I RELATIVI COMPONENTI DISASSEMBLATI, (FIG. 1).

**NOTE:** ALL ITEMS ARE DISPLAYED ASSEMBLED FOR A BETTER UNDERSTANDING OF THE PRODUCT. PLEASE NOTE THAT, UNLESS OTHERWISE REQUESTED, ALL ORDERED ITEMS ARE DELIVERED WITH THE RELEVANT COMPONENTS DISASSEMBLED. (PIC. 1).

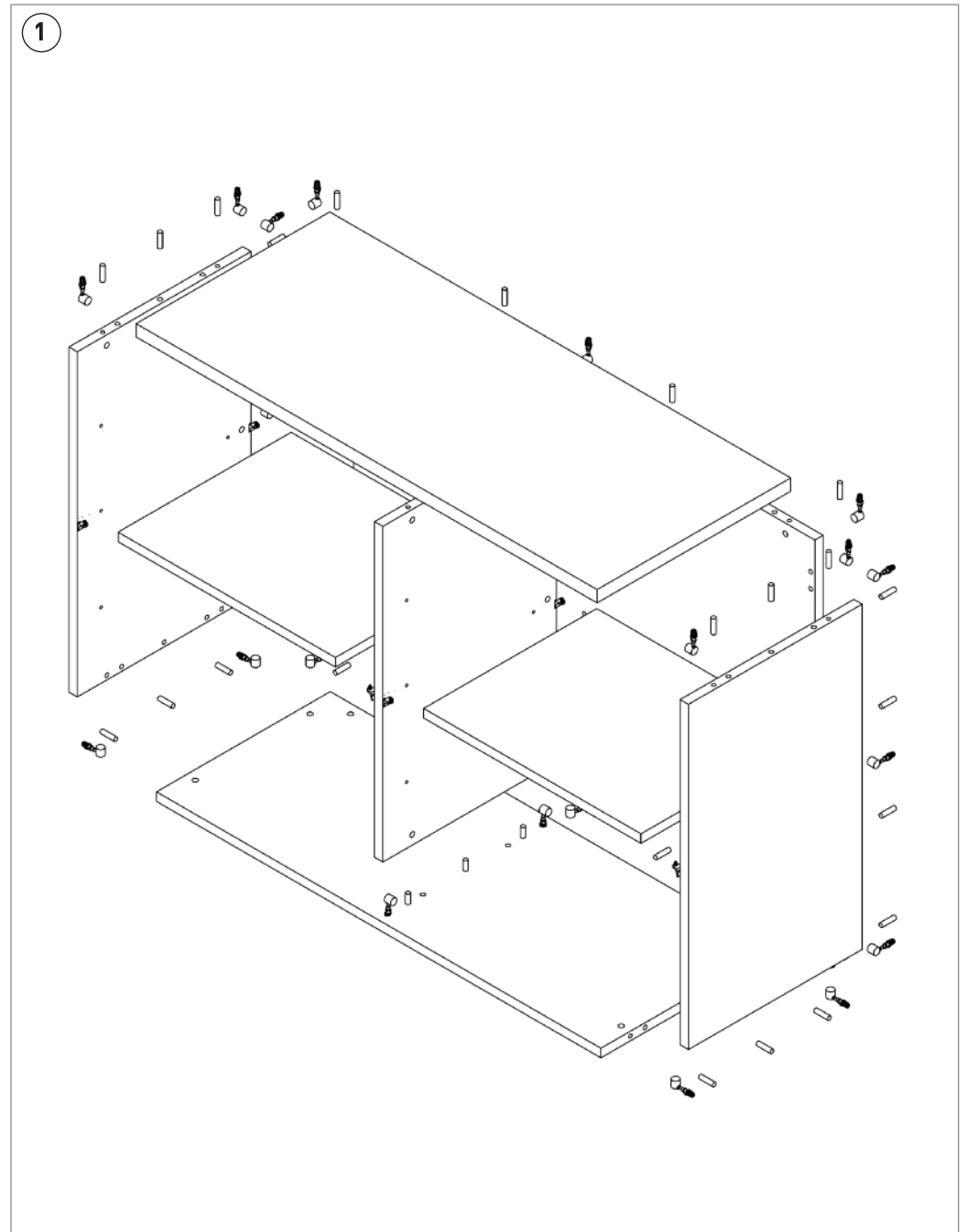

artheta<sup>®</sup>  
IIII GROUP

ARTHEMAGROUP s.r.l.

Via Cascina Restelli, 5 - 20040 Aicurzio (MB) Italy

Tel. +39 0396093099 - Fax +39 0396093307

arthemagroup@arthemagroup.it - www.arthemagroup.it